



**SYSTÈME INOX
D'ARCHITECTURE
PAR CÂBLES**

Catalogue



Waltermann

*Boulevard Bellevue
F-57310 GUENANGE*

Sommaire

Article	Page	Article	Page	Article	Page
Anneau de fixation	42	Mini-Terminaison à tête fraisée	21	Tendeur à cage ouverte à 2 chapes	65
Anneau fileté	66	Mini-Terminaison à vis à chape	25	Tendeur à cage ouverte à 2 crochets	65
Anneau taraudé	66	Mini-Terminaison à vis à œil	25	Tendeur à cage ouverte à 2 oeils	65
Arrêt butoir	44	Mini-Terminaison à vis à tige filetée	25	Tendeur à cage ouverte à œil et crochet	65
Arrêt d'extrémité	45	Mini-Terminaison à vis taraudée	25	Terminaison à chape, montage manuel	26
Arrêt multi-angles poteau plat	39	Mini-Terminaison simple	18	Terminaison à chape, standard	20
Arrêt multi-angles poteau rond	39	Mini-Terminaison taraudée	22	Terminaison à œil, montage manuel	26
Attache cornière		Mini-Terminaison type KW	19	Terminaison à œil, standard	22
pour support de rayonnage	48	Mini-Terminaison type KW filetage long	19	Terminaison à tige filetée, montage manuel	26
Attache plate pour		Mini-Tige filetée à chape	34	Terminaison conique taraudée, montage manuel	26
support de rayonnage	48	Mini-Tige filetée à œil	34	Terminaison cylindrique	42
Boule taraudée	45	Mousqueton	66	Terminaison simple, standard	18
Cache Inox	54	Œil fileté	46	Terminaison taraudée à droite, montage manuel	25
Cage de ridoir pour Mini et Super-Mini	31	Œil taraudé	46	Tige filetée	61
Cage de ridoir, standard	31	Pince coupante pour câble	27	Tige filetée à œil, standard	34
Cale d'épaisseur pour serre-câble de fix. d'angle	36	Piton à œil fileté	62	Vis Allen tête basse DIN 6912	60
Capuchon de douille	42	Positionneur d'angle multiple, poteau plat	38	Vis Allen tête fraisée DIN 7991	60
Chaîne, maille courte	67	Positionneur d'angle multiple, poteau rond	38	Vis à double filet bois/métaux	61
Chaîne, maille longue	67	Ridoir 2 chapes, standard	31	Vis à œil DIN 444, filetage bois	62
Chape à émerillon	35	Ridoir 2 terminaisons simples, standard	28	Vis à œil DIN 444, filetage métrique	62
Chape à visser	35	Ridoir chape et terminaison simple, standard	29	Vis cruciforme pour bois aggloméré	60
Console murale std - pour chape ou terminaison	54	Ridoir œil et terminaison simple, standard	32	Vis six pans à bois DIN 571	60
Console petit modèle	55	Rondelle DIN 125, forme A	62		
Console type Y	55	Rondelle spéciale pour poteau rond	39		
Cosse	64	Rosace	54		
Déco-douille de tension	43	Serre-câble à étrier, série légère	64		
Display-support	50	Serre-câble à étrier, série lourde	64		
Douille à œil	56	Serre-câble croisé, 3 D M8 et M12	52		
Douille à visser	42	Serre-câble croisé, multi-angles	53		
Douille de tension	35	Serre-câble croisé, multi-angles, fixation murale	53		
Ecrou anti-desserrage DIN 985	63	Serre-câble croisé, multi-angles, fixation murale avec 1 déviation à œil	53		
Ecrou à six pans DIN 934	63	Serre-câble croisé, multi-angles, fixation murale avec 2 déviations à œil	53		
Ecrou bas à six pans DIN 439	63	Serre-câble croisé simple avec fixation murale M 8	52		
Ecrou borgne DIN 1587	63	Serre-câble croisé simple avec fixation murale M 12	52		
Élément de protection et de déviation	56	Serre-câble de fixation	36		
Goujon	61	Serre-câble de fixation à rotule	36		
Maillon rapide	66	Serre-câble de fixation d'extrémité	36		
Manchon serre-câble	27	Serre-câble plat, 1 boulon	64		
Manchon de tension	35	Serre-câble plat, 2 boulons	64		
Manille droite	67	Super-Mini-Cage de ridoir longue	30		
Manille lyre	67	Super-Mini-Ridoir chape et terminaison simple	29		
Maxi-Terminaison	5	Super-Mini-Ridoir chape et terminaison simple long	30		
Maxi-Terminaison à chape, usinée	5	Super-Mini-Ridoir 2 chapes long	30		
Maxi-Terminaison à chape, soudée	5	Super-Mini-Ridoir 1 terminaison simple	33		
Maxi-Terminaison à œil	6	Super-Mini-Ridoir 2 terminaisons simples	28		
Maxi-Chape filetée, usinée	6	Super-Mini-Ridoir 2 terminaisons simples long	30		
Maxi-Chape filetée, soudée	6	Super-Mini-Terminaison à chape	20		
Maxi-Œil	7	Super-Mini-Terminaison à tête bombée	21		
Maxi-Corps de ridoir	7	Super-Mini-Terminaison à tête fraisée	21		
Maxi-Ecrous	7	Super-Mini-Terminaison simple	19		
Maxi-Ridoir chape (usinée) et terminaison	8	Super-Mini-Terminaison simple filetage long	19		
Maxi-Ridoir chape (soudée) et terminaison	8	Super-Mini-Tige filetée à chape longue	34		
Maxi-Ridoir œil et terminaison	8	Support à chape	51		
Maxi-Ridoir deux terminaisons	9	Support de rayonnage	48		
Maxi-Ridoir deux chapes (usinée)	9	Suspension monobrin avec bague	40		
ASS Maxi-Ridoir deux chapes (soudée)	9	Suspension monobrin avec boulon à œil	41		
Mini-Chape taraudée	35	Suspension multibrins	41		
Mini-Ridoir 1 chape	33	Système de suspension	70		
Mini-Ridoir 1 terminaison simple	33				
Mini-Ridoir 2 chapes	31				
Mini-Ridoir 2 terminaisons simples	28				
Mini-Ridoir chape et terminaison simple	29				
Mini-Ridoir œil et terminaison simple	32				
Mini-Ridoir tige filetée et terminaison simple	32				
Mini-Terminaison à chape	20				
Mini-Terminaison à œil	22				



ASS[®]
MAXI



Pour câbles Inox
du diamètre 12 à 26 mm.

For stainless steel wire ropes
diameter 12 up to 26 mm.



LA QUALITE EN ACIER INOXYDABLE

DIAMETRE EXTERIEUR DES TERMINAISONS AVANT/APRES SERTISSAGE:
DIAMETER OF THE TERMINAL BEFORE/AFTER PRESSING OR SWAGING:

câble-Ø rope-Ø mm	intérieur-Ø internal Ø d ₃ mm	extérieur-Ø/outside-Ø d ₂	
		avant/before mm	apres/after mm
12	12,5	20,0	17,60 – 17,80
14	14,8	25,0	22,00 – 22,23
16	17,0	28,0	25,15 – 25,40
19	20,0	34,5	31,44 – 31,75
22	23,5	40,5	36,20 – 36,50
26	27,5	46,0	40,97 – 41,28

CHARGES DE RUPTURE
MINIMUM BREAKING LOADS

Les charges de rupture indiquées dans ce catalogue sont valables pour l'article spécifié. Elles sont déterminées en fonction du filetage, de l'oeil, de la chape et de l'axe de chape.

L'utilisateur est responsable de la conformité du choix du câble ainsi que du bon sertissage.

The minimum breaking loads given in this catalogue are applicable for the specified item. They are determined by the thread, eye or jaw and pin of the relevant item.

The user is responsible for the correct choice of rope and for correct swaging or pressing.



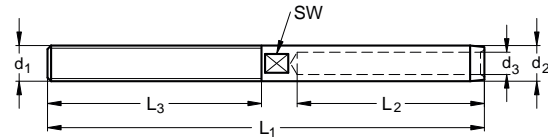

ASS Maxi-Terminaison
filetage à droite ou à gauche

ASS Threaded Terminal, Maxi type
with right and left hand thread

câble-Ø <i>rope-Ø</i> mm	Filetage <i>thread</i> d ₁	d ₂ mm	d ₃ mm	L ₁ mm	L ₂ mm	L ₃ mm	SW mm	Charge de rupture* <i>min. breaking</i> <i>load*</i> kg	Filetage à droite <i>right hand thread</i> N° article <i>stock no.</i>	Filetage gauche <i>left hand thread</i> N° article <i>stock no.</i>
12	M 20	20,0	12,5	249	105	120	17	11.400	371 101 220	371 201 220
14	M 22	25,0	14,8	308	140	140	22	15.900	371 101 422	371 201 422
16	M 22	28,0	17,0	333	160	140	25	18.200	371 101 622	371 201 622
16	M 24	28,0	17,0	363	160	170	25	19.400	371 101 624	371 201 624
19	M 27	34,5	20,0	425	200	180	30	23.000	371 101 927	371 201 927
22	M 30	40,5	23,5	480	230	200	36	28.000	371 102 230	371 202 230
26	M 36	46,0	27,5	550	280	220	41	41.000	371 102 636	371 202 636

* Attention à ne pas confondre Charge de Rupture et CMU.
* These figures are breaking load limits, not working load limits.

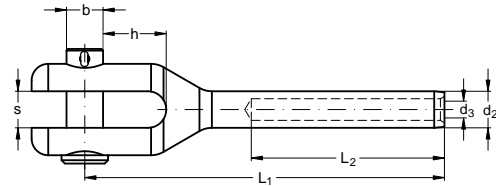

ASS Maxi-Terminaison à chape, usinée

ASS Machined Jaw Terminal, Maxi type

câble-Ø <i>rope-Ø</i> mm	d ₂ mm	d ₃ mm	L ₁ mm	L ₂ mm	h mm	s mm	b mm	Charge de rupture* <i>min. breaking load*</i> kg	N° article <i>stock no.</i>
12	20,0	12,5	197	105	35,5	20	19	9.500	371 021 012
14	25,0	14,8	239	140	38,0	22	22	15.000	371 021 014
16	28,0	17,0	271	160	39,3	25	25,4	19.000	371 021 016
19	34,5	20,0	327	200	41,0	30	28	27.000	371 021 019
22	40,5	23,5	377	230	51,0	35	32	35.000	371 021 022
26	46,0	27,5	434	280	49,5	35	35	48.000	371 021 026

* Attention à ne pas confondre Charge de Rupture et CMU.
* These figures are breaking load limits, not working load limits.

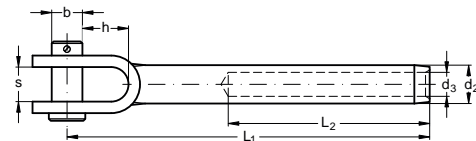

ASS Maxi-Terminaison à chape, soudée

ASS Welded Jaw Terminal, Maxi type

câble-Ø <i>rope-Ø</i> mm	d ₂ mm	d ₃ mm	L ₁ mm	L ₂ mm	h mm	s mm	b mm	Charge de rupture* <i>min. breaking load*</i> kg	N° article <i>stock no.</i>
12	20	12,5	189	105	41,0	24	19	11.200	371 020 012
14	25	14,8	232	140	46,5	30	22	15.000	371 020 014
16	28	17,0	264	160	49,5	30	25	19.000	371 020 016

Attention à ne pas confondre Charge de Rupture et CMU.
* These figures are breaking load limits, not working load limits.



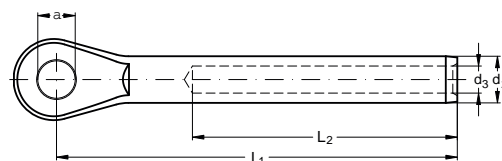

ASS Maxi-Terminaison à oeil

ASS Eye Terminal, Maxi type

câble-Ø <i>rope-Ø</i> mm	d ₂ mm	d ₃ mm	L ₁ mm	L ₂ mm	a mm	s mm	Charge de rupture* <i>min. breaking load*</i> kg	N° article <i>stock no.</i>
12	20	12,5	156	105	19,3	15	11.400	371 025 012
14	25	14,8	205	140	23	18	15.900	371 025 014
16	28	17,0	232	160	26	20	19.000	371 025 016
19	34,5	20,0	302	200	28,5	25	31.000	371 025 019
22	40,5	23,5	348	230	33	30	42.000	371 025 022
26	46	27,5	400	280	36	30	53.000	371 025 026

* Attention à ne pas confondre Charge de Rupture et CMU.

* *These figures are breaking load limits, not working load limits.*

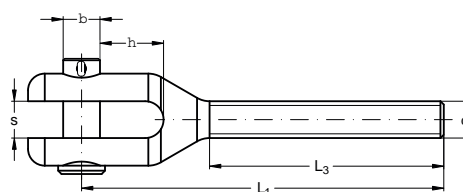

ASS Maxi-Chape fileté, usinée
filetage à droite ou à gauche

ASS Machined Threaded Jaw, Maxi type
with right and left hand thread

Désignation <i>nominal size</i>	Filetage <i>thread</i> d ₁	L ₁ mm	L ₃ mm	h mm	s mm	b mm	Charge de rupture* <i>min. breaking load*</i> kg	Filetage à droite <i>right hand thread</i> N° article <i>stock no.</i>	Filetage à gauche <i>left hand thread</i> N° article <i>stock no.</i>
M 20	M 20	219,5	125	35,5	20	19	12.000	371 522 020	371 523 020
M 22	M 22	216	140	38,0	22	22	15.000	371 522 022	371 523 022
M 24	M 24	255	170	39,3	25	25	18.000	371 522 024	371 523 024
M 27	M 27	274	180	41,0	30	28	23.000	371 522 027	371 523 027
M 30	M 30	316	200	51,0	35	32	28.000	371 522 030	371 523 030
M 36	M 36	334	220	49,5	35	35	41.000	371 522 036	371 523 036

* Attention à ne pas confondre Charge de Rupture et CMU.

* *These figures are breaking load limits, not working load limits.*

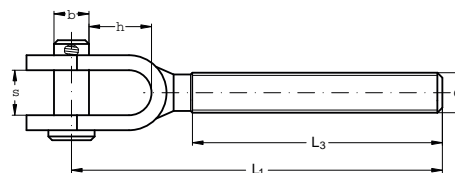

ASS Maxi-Chape fileté, soudée
filetage à droite ou à gauche

ASS Welded Threaded Jaw, Maxi type
with right and left hand thread

Désignation <i>nominal size</i>	Filetage <i>thread</i> d ₁	L ₁ mm	L ₃ mm	h mm	s mm	b mm	Charge de rupture* <i>min. breaking load*</i> kg	Filetage à droite <i>right hand thread</i> N° article <i>stock no.</i>	Filetage à gauche <i>left hand thread</i> N° article <i>stock no.</i>
M 20	M 20	193	120	41,0	24	19,0	14.000	371 520 020	371 521 020
M 22	M 22	224,5	140	46,5	30	22,0	18.000	371 520 022	371 521 022
M 24	M 24	258	170	49,3	30	25,4	21.000	371 520 024	371 521 024

* Attention à ne pas confondre Charge de Rupture et CMU.

* *These figures are breaking load limits, not working load limits.*

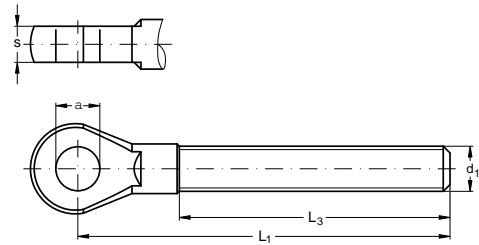

ASS Maxi-Oeil
filetage à droite

ASS Threaded Eye, Maxi type
with right hand thread

Désignation nominal size	Filetage thread d ₁	L ₁ mm	L ₃ mm	a mm	s mm	Charge de rupture* min. breaking load* kg	N° article stock no.
M 20	M 20	164	120	19,5	15	14.700	371 510 020
M 22	M 22	196,5	140	23,0	18	15.200	371 510 022
M 24	M 24	230	170	25,5	20	17.700	371 510 024
M 27	M 27	247,5	180	28,5	25	23.000	371 510 027
M 30	M 30	274	200	32,5	30	28.000	371 510 030
M 36	M 36	297	220	35,5	30	41.000	371 510 036

Attention à ne pas confondre Charge de Rupture et CMU.

* These figures are breaking load limits, not working load limits.

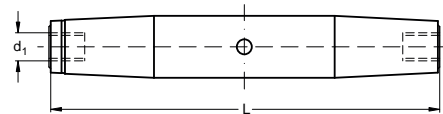

ASS Maxi-Corps de ridoir
Avec bague taraudée en bronze
Garantissant une utilisation durable
même sous forte charge



ASS Rigging Screw - body, Maxi type
Internal thread made of bronze
This guarantees longterm use,
even under heavy load.

Désignation nominal size	Filetage thread d ₁	L mm	Charge de rupture* min. breaking load* kg	N° article stock no.
M 20	M 20	240	14.700	371 213 020
M 22	M 22	270	18.000	371 213 022
M 24	M 24	325	21.000	371 213 024
M 27	M 27	345	23.000	371 213 027
M 30	M 30	375	28.000	371 213 030
M 36	M 36	410	41.000	371 213 036

* Attention à ne pas confondre Charge de Rupture et CMU.

* These figures are breaking load limits, not working load limits.

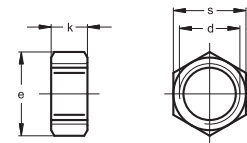

ASS Maxi-Ecrous
filetage à droite ou à gauche

ASS Lock Nut, Maxi type
with right and left hand thread

Désignation nominal size	Filetage thread d ₁	e mm	s mm	k mm	Filetage à droite right hand thread N° article stock no.	Filetage à gauche left hand thread N° article stock no.
M 20	M 20	27,7	24	13,0	371 010 020	371 011 020
M 22	M 22	34,6	30	16,5	371 010 022	371 011 022
M 24	M 24	41,6	36	17,5	371 010 024	371 011 024
M 27	M 27	47,3	41	22,0	371 010 027	371 011 027
M 30	M 30	53,1	46	24,0	371 010 030	371 011 030
M 36	M 36	63,5	55	29,0	371 010 036	371 011 036



ASS Maxi-Ridoir

chape (usinée, filetage à gauche) et terminaison

Avec bague taroudée en bronze

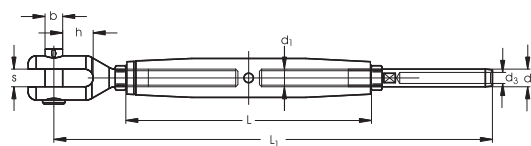

ASS Rigging Screw, Maxi type

with jaw (machined) and terminal

Internal thread made of bronze

câble-Ø rope-Ø mm	Filetage thread d ₁	d ₂ mm	d ₃ mm	h mm	s mm	b mm	L mm	L ₁ mm	Charge de rupture* min. breaking load* kg	N° article stock no.
12	M 20	20,0	12,5	35,5	20	19	240	489,5	11.400	371 241 220
14	M 22	25,0	14,8	38	22	22	270	547	15.000	371 241 422
16	M 22	28,0	17,0	38	22	22	270	572	15.000	371 241 622
16	M 24	28,0	17,0	39,5	25	25	325	638	18.000	371 241 624
19	M 27	34,5	20,0	41	30	28	345	728	23.000	371 241 927
22	M 30	40,5	23,5	51	35	32	375	819	28.000	371 242 230
26	M 36	46,0	27,5	49,5	35	35	410	906	41.000	371 242 636

* Attention à ne pas confondre Charge de Rupture et CMU.

* These figures are breaking load limits, not working load limits.



ASS Maxi-Ridoir

chape (soudée, filetage à gauche) et terminaison

Avec bague taroudée en bronze

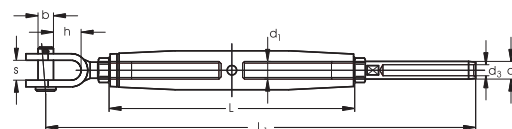

ASS Rigging Screw, Maxi type

with jaw (welded) and terminal

Internal thread made of bronze

câble-Ø rope-Ø mm	Filetage thread d ₁	d ₂ mm	d ₃ mm	h mm	s mm	b mm	L mm	L ₁ mm	Charge de rupture* min. breaking load* kg	N° article stock no.
12	M 20	20	12,5	41,0	24	19	240	466	11.400	371 251 220
14	M 22	25	14,8	46,5	30	22	270	555,5	15.900	371 251 422
16	M 22	28	17,0	46,5	30	22	270	580,5	18.000	371 251 622
16	M 24	28	17,0	49,3	30	25,4	325	641	19.400	371 251 624

* Attention à ne pas confondre Charge de Rupture et CMU.

* These figures are breaking load limits, not working load limits.



ASS Maxi-Ridoir

oeil (filetage à droite) et terminaison

Avec bague taroudée en bronze

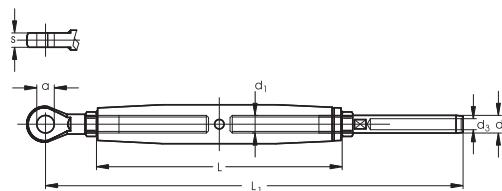

ASS Rigging Screw, Maxi type

with eye and terminal

Internal thread made of bronze

câble-Ø rope-Ø mm	Filetage thread d ₁	d ₂ mm	d ₃ mm	a mm	s mm	L mm	L ₁ min. breaking load*	Charge de rupture* min. breaking load* kg	N° article stock no.
12	M 20	20,0	12,5	19,5	15	240	439	11.400	371 271 220
14	M 22	25,0	14,8	23	18	270	527,5	15.200	371 271 422
16	M 22	28,0	17,0	23	18	270	552,5	15.200	371 271 622
16	M 24	28,0	17,0	25,5	20	325	613	17.700	371 271 624
19	M 27	34,5	20,0	28,5	25	345	701,5	23.000	371 271 927
22	M 30	40,5	23,5	32,5	30	375	777	28.000	371 272 230
26	M 36	46,0	27,5	35,5	30	410	869	41.000	371 272 636

* Attention à ne pas confondre Charge de Rupture et CMU.

* These figures are breaking load limits, not working load limits.

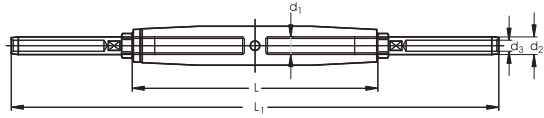

ASS Maxi-Ridoir

deux terminaisons

Avec bague taraudée en bronze

ASS Rigging Screw, Maxi type

with terminal and terminal

Internal thread made of bronze

câble-Ø rope-Ø mm	Filetage thread d ₁	d ₂ mm	d ₃ mm	L mm	L ₁ mm	Charge de rupture* min. breaking load* kg	N° article stock no.
12	M 20	20,0	12,5	240	524	11.400	371 261 220
14	M 22	25,0	14,8	270	639	15.900	371 261 422
16	M 22	28,0	17,0	270	689	18.000	371 261 622
16	M 24	28,0	17,0	325	746	19.400	371 261 624
19	M 27	34,5	20,0	345	879	23.000	371 261 927
22	M 30	40,5	23,5	375	983	28.000	371 262 230
26	M 36	46,0	27,5	410	1122	41.000	371 262 636

* Attention à ne pas confondre Charge de Rupture et CMU.

* These figures are breaking load limits, not working load limits.

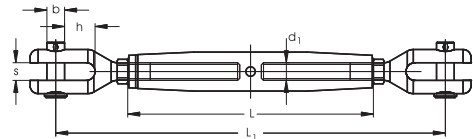

ASS Maxi-Ridoir

deux chapes (usinées)

Avec bague taraudée en bronze

ASS Rigging Screw, Maxi type

with jaw and jaw (machined)

Internal thread made of bronze

Désignation nominal size	Filetage thread d ₁	h mm	s mm	b mm	L mm	L ₁ mm	Charge de rupture* min. breaking load* kg	N° article stock no.
M 20	M 20	35,5	20	19	240	455	12.000	371 220 020
M 22	M 22	38	22	22	270	455	15.000	371 220 022
M 24	M 24	39,5	25	25	325	530	18.000	371 220 024
M 27	M 27	41	30	28	345	577	23.000	371 220 027
M 30	M 30	51	35	32	375	665	28.000	371 220 030
M 36	M 36	49,5	35	35	410	690	41.000	371 220 036

* Attention à ne pas confondre Charge de Rupture et CMU.

* These figures are breaking load limits, not working load limits.

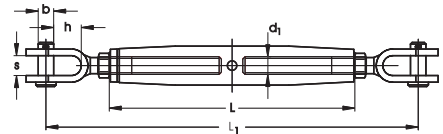

ASS Maxi-Ridoir

deux chapes (soudées)

Avec bague taraudée en bronze

ASS Rigging Screw, Maxi type

with jaw and jaw (welded)

Internal thread made of bronze

Désignation nominal size	Filetage thread d ₁	h mm	s mm	b mm	L mm	L ₁ mm	Charge de rupture* min. breaking load* kg	N° article stock no.
M 20	M 20	41	24	19	240	408	14.000	371 230 020
M 22	M 22	46,5	30	22	270	472	18.000	371 230 022
M 24	M 24	49,3	30	25,4	325	536	21.000	371 230 024

* Attention à ne pas confondre Charge de Rupture et CMU.

* These figures are breaking load limits, not working load limits.





ASS[®]

SUPER-MINI

*La tendance actuelle
du système de décoration*

An uptodate ornamental system



*La finesse au service
de la robustesse*

*The best things come in a
small package*



LA QUALITE EN ACIER INOXYDABLE

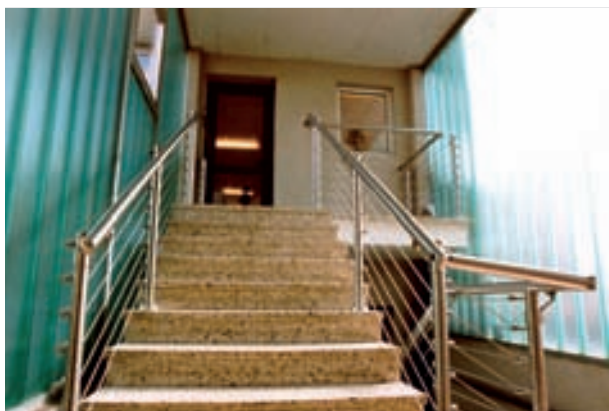

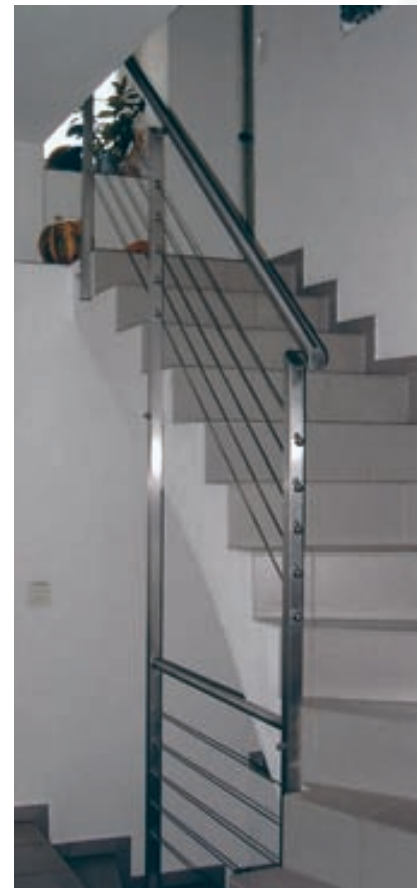
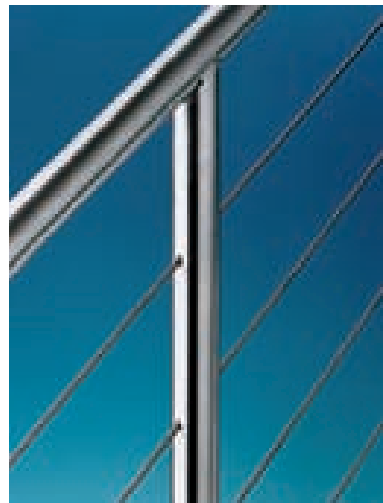
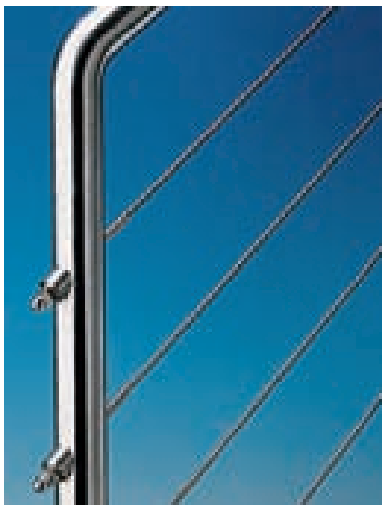
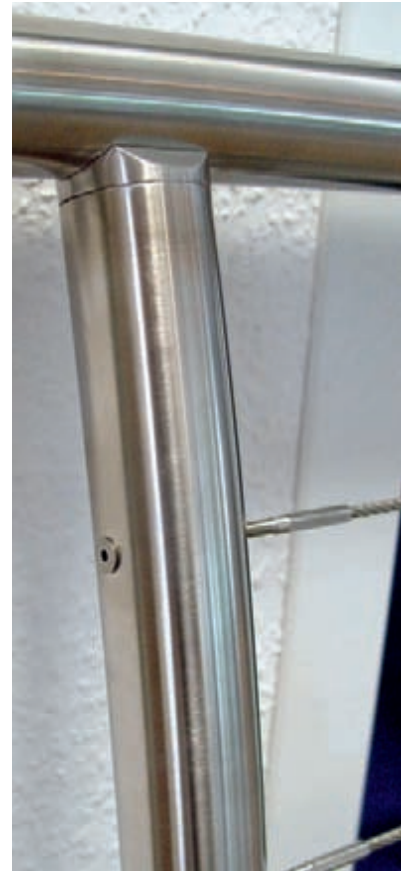

CHARGES DE RUPTURE DES CÂBLES MUNIS DE TERMINAISONS SERTIES (STANDARD, MINI ET SUPERMINI)

Ø câble mm	Câble similaire EN 12385-4 6x7 avec âme métallique classe de résistance 1570 N/mm ² AISI 316 kN	Câble similaire EN 12385-4 6x19 M avec âme métallique classe de résistance 1570 N/mm ² AISI 316 kN
2	2,02	1,87
3	4,56	4,23
4	8,09	7,47
5	12,64	11,68
6	18,27	16,85
7	24,84	22,95
8	32,49	30,02
10	50,67	46,89



D'autres classes de câbles et/ou d'autres constructions peuvent engendrer d'autres charges de rupture. L'utilisation de câbles de ruptures plus élevées peut avoir pour conséquence une diminution de la charge de rupture donnée. Les charges de ruptures se rapportent à des essais statiques sous réserve d'un sertissage correct. **Elles correspondent à 90% de la charge de rupture des câbles.**

DIAMETRE EXTERIEUR DES TERMINAISONS AVANT/APRES SERTISSAGE

Ø câble mm	Standard et Mini diamètre extérieur		Super-Mini diamètre extérieur	
	Avant mm	Après mm	Avant mm	Après mm
2	---	---	4,5	3,95 - 4,2
3	6,3	5,4 - 5,7	5,4	4,5 - 4,8
4	7,5	6,4 - 6,7	6,5	5,4 - 5,7
5	9,0	7,8 - 8,2	7,5	6,4 - 6,7
6	12,5	10,8 - 11,1	9,0	7,8 - 8,2
7	14,2	12,6 - 12,9	---	---
8	16,0	14,0 - 14,3	12,5	10,8 - 11,1
10	18,0	15,5 - 15,8	---	---



Les valeurs indiquées dans les colonnes „Après“ du tableau ci-dessus s'expliquent par l'ovalisation de la terminaison après sertissage. Ces valeurs sont le résultat des cotes relevées avant les essais de rupture. Le diamètre minimum, après sertissage, ne devra pas dévier de plus de 0,1 mm de la valeur inférieure.



Veillez noter que nos terminaisons ne peuvent être serties qu'avec des presses à galets ou à matrices.

Sertissage d'une terminaison simple à l'aide d'une presse à galets



Les essais effectués sur des bancs de traction modernes assurent une qualité de production sûre.



Essai de rupture d'un ridoir.



CHARGES DE RUPTURE DES RIDOIRS A CHAPE, A ŒIL ET/OU A TIGE FILETEE

Ø filetage	diamètre du câble utilisé avec			Standard, Mini-, Super-Mini Charge de rupture kN
	Standard mm	Mini mm	Super-Mini mm	
M 4	---	---	3	4,55
M 5	2,5	3	4	8,15
M 6	3	4	5	12,60
M 8	4	5	6	18,20
M 10	5	6	8	32,40
M 12	6	8	---	40,00
M 14	7	---	---	55,00
M 16	8	10	---	65,00
M 20	10	---	---	85,00



Les valeurs indiquées sont également valables pour les pièces détachées des ridoirs. Les charges de rupture se rapportent à des essais statiques. **Dans le cas de ridoirs à 1 ou 2 terminaisons à sertir, la charge de rupture est donnée par les terminaisons.**



Les charges de rupture reposent sur les contrôles courants de nos produits réalisés sur des bancs d'essais validés par un organisme officiel. (Materialprüfungsamt Nordrhein-Westfalen).

En outre, les terminaisons à sertir (de 3 à 10 mm) ainsi que les ridoirs (à chape ou à œil) qui figurent dans ce catalogue, ont été testés par la société Deutsche Montan Technologie GmbH (DMT) Geschäftsfeld Bergbau Service Seil- & Fördertechnik (anciennement Seilprüfstelle Bochum).

Ces valeurs servent de références.

Instructions pour un sertissage correct des terminaisons

Presse / Presse à Galets

STANDARD et ASSMINI

seront sertis avec les matrices ou les galets habituels recommandés par le fabricant de la presse.

ASSSUPER-MINI

seront sertis avec les matrices ou les galets du diamètre inférieur.

Ex. : ASSSUPER-MINI Ø câble 4 mm avec les matrices ou les galets Ø câble 3 mm
Ø câble 3 mm avec les matrices ou les galets Ø câble 2,5 mm

Attention : les Ø câbles 8 mm sont à sertir avec les matrices ou galets de 6 mm standard pour les Ø câbles de 2 mm, il faut un outillage spécial

ASSMINI et ASSSUPER-MINI ne nécessitent pas d'investir dans de nouveaux outillages.

Positionnement

Veuillez vous référer au croquis ci-dessous.

Valable pour toute sorte de presse

Pas de bourrelet après le sertissage des ASSSUPER-MINI.

ASSSUPER-MINI = Attractif, Solide et Sûr.

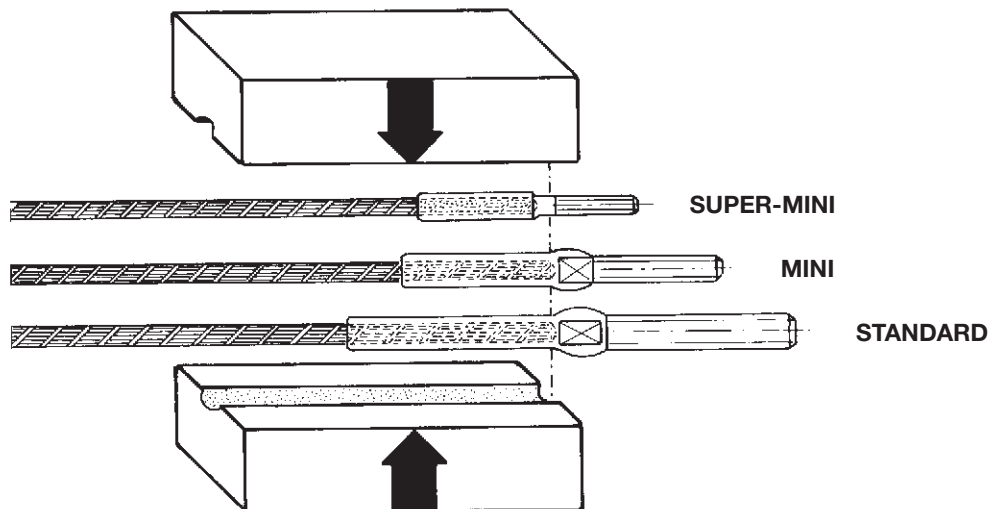

Instructions for the correct pressing/rolling of threaded terminals

Pressing/Rolling

Standard and ASSMini type

Use the standard dies/swages as recommended by the machine manufacturer.

ASSSuper-Mini

as a rule use the next size die/swage down, e.g.

ASSSuper-Mini type for Ø 4 mm use die/swage for Ø 3 mm rope.
Ø 3 mm use die/swage for Ø 2,5 mm rope.

Attention: Ø 8 mm use die/swage for Ø 6 mm standard.
For pressing/rolling of ASSSUPER-MINI terminals for Ø 2 mm as special tool is required.

Standard dies/swages are used for the ASSMini and ASSSuper-Mini type (besides Ø 2 mm).

Please see above drawing for the positioning of wire rope and terminal before pressing.

The same criteria applies for both pressing and roll swaging.

There should be no flash after pressing/roll swaging the ASSSuper-Mini.

ASSSuper-Mini = Aesthetic, Strong, Safe

Construction des câbles

7 x 7 suivant DIN 3055
7 x 19 suivant DIN 3060

1 x 19 suivant DIN 3053

Important !

Tout changement de cote nous est réservé. Dans le besoin de cotes plus précises, veuillez nous consulter.

Avec la parution de ce catalogue toutes les anciennes cotes sont périmées.

Rope constructions

7 x 7 according to DIN 3055
7 x 19 according to DIN 3060

1 x 19 according to DIN 3053

Important note!

All dimensions are subject to change without notice. If exact dimensions are required please reconfirm with us.

This edition supercedes all previous editions.

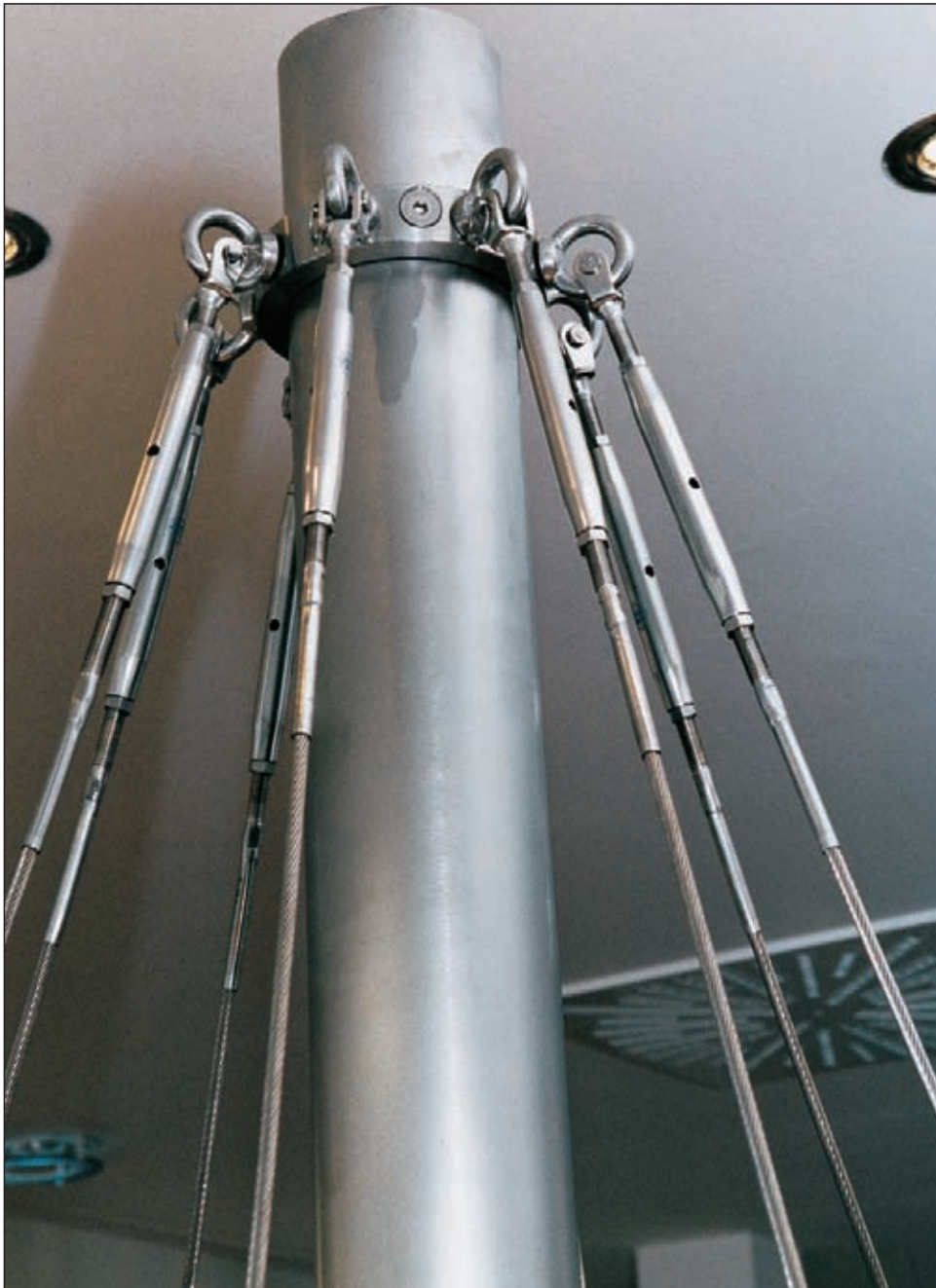

Sous réserve d'un sertissage correct, les données techniques se rapportent à des charges statiques et non des charges dynamiques.

This information is based on static and not on dynamic loads, assuming correctly swaged terminals.

Charge de rupture des terminaisons serties

Breaking load limit of terminals swaged on a wire rope

STANDARD

≥ 90 % de la rupture du câble
 ≥ 90 % of the minimum breaking load of the rope

MINI

≥ 90 % de la rupture du câble
 ≥ 90 % of the minimum breaking load of the rope

SUPER-MINI

≥ 90 % de la rupture du câble
 ≥ 90% of the minimum breaking load of the rope

Attention ne pas confondre la charge de rupture avec la charge utile.

Please do not mix up breaking load limits with working load limits.

Ces résultats reposent sur des essais avec des câbles 7 x 7 suivant DIN 3055 et 7 x 19 suivant DIN 3060.

These results are based on breaking tests with wire ropes 7 x 7 according to DIN 3055 and 7 x 19 according to DIN 3060.

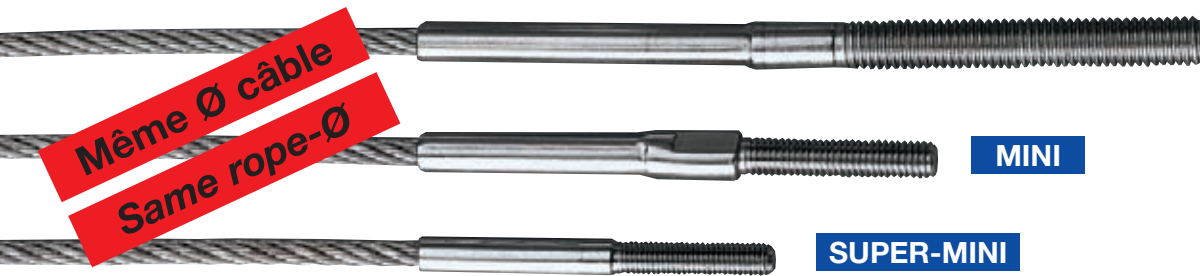

STANDARD

MINI

SUPER-MINI

UN diamètre câble - TROIS générations de terminaisons
One rope diameter - three connector options

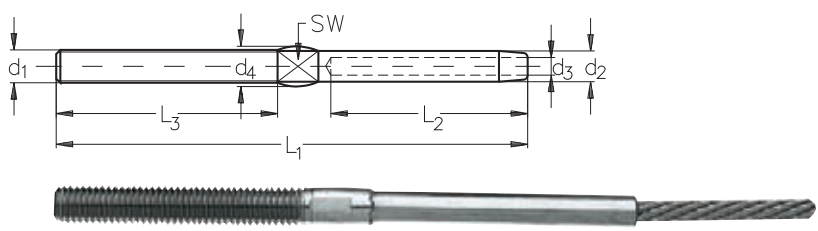

Terminaison simple INOX
 filetage à droite ou à gauche
 standard

NIRO Threaded Terminal
 with right and left hand thread
 Standard type

Ø câble rope-Ø mm	Filetage thread d ₁	d ₂ mm	d ₃ mm	d ₄ mm	L ₁ mm	L ₂ mm	L ₃ mm	SW mm	Filetage à droite right hand thread N° article stock no.	Filetage à gauche left hand thread N° article stock no.
2,5	M 5	5,4	2,7	6,5	86	35	40	4	301 010 005	301 011 005
3	M 6	6,3	3,3	7,0	97	38	48	5	301 010 006	301 011 006
4	M 8	7,5	4,3	8,5	115	45	54	6	301 010 008	301 011 008
5	M 10	9,0	5,3	10,5	128	52	61	7	301 010 010	301 011 010
6	M 12	12,5	6,3	13,5	162	63	79	10	301 010 012	301 011 012
7	M 14	14,2	7,3	15,0	178	70	90	12	301 010 014	-
8	M 16	16,0	8,3	17,0	214	80	102	14	301 010 016	301 011 016
10	M 20	17,8	10,5	18,5	215	90	105	15	301 010 020	301 011 020

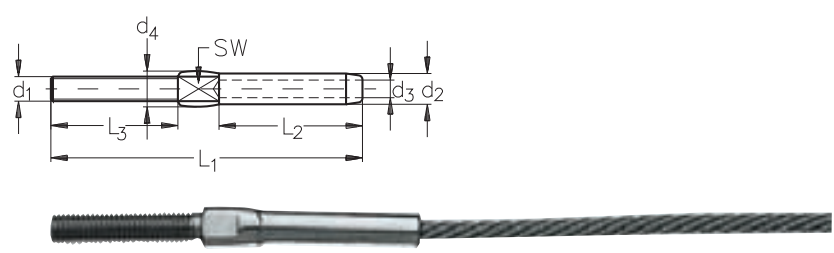

ASS Mini-Terminaison simple INOX
 filetage à droite ou à gauche

ASS Threaded Terminal, Mini type
 with right and left hand thread

DBGM design protégé
 registered design

Ø câble rope-Ø mm	Filetage thread d ₁	d ₂ mm	d ₃ mm	d ₄ mm	L ₁ mm	L ₂ mm	L ₃ mm	SW mm	Filetage à droite right hand thread N° article stock no.	Filetage à gauche left hand thread N° article stock no.
3	M 5	6,3	3,3	7,0	58	27	25	5	311 010 005	311 011 005
4	M 6	7,5	4,3	8,5	75	35	30	6	311 010 006	311 011 006
5	M 8	9,0	5,3	10,5	80	40	30	7	311 010 008	311 011 008
6	M 10	12,5	6,3	14,0	105	50	40	10	311 010 010	311 011 010

Attention ! Après sertissage la cote d₄ est la plus épaisse.

Please take the dimension d₄ into consideration which is determined by the pressing.

Sans précision, les articles ci-dessus seront livrés filetés à droite.
 All items are delivered with right hand thread unless specified otherwise.



ASS Mini-Terminaison simple type KW
filetage à droite ou à gauche

ASS Threaded terminal type KW, Mini type
with right and left hand thread

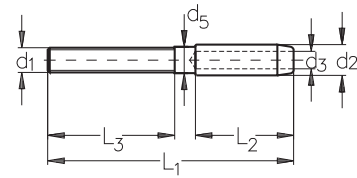

DBGM

Ø câble rope-Ø mm	Filetage thread d ₁	d ₂ mm	d ₃ mm	d ₅ mm	L ₁ mm	L ₂ mm	L ₃ mm	Filetage à droite right hand thread N° article stock no.	Filetage à gauche left hand thread N° article stock no.
3	M 5	6,3	3,3	5,5	48	18	25	311 014 005	311 015 005
4	M 6	7,5	4,3	6,4	59	24	30	311 014 006	311 015 006
5	M 8	9,0	5,3	7,8	68	30	30	311 014 008	311 015 008
6	M 10	12,5	6,3	10,8	84	36	40	311 014 010	311 015 010
8	M 12	16,0	8,3	14,0	115	55	50	311 014 012	311 015 012
10	M 16	17,8	10,5	15,5	142	70	60	311 014 016	311 015 016



ASS Mini-Terminaison simple type KW
filetage long à droite ou à gauche

ASS Threaded terminal type KW, Mini type
with extra long thread, right and left hand

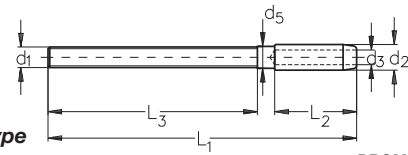

DBGM

Ø câble rope-Ø mm	Filetage thread d ₁	d ₂ mm	d ₃ mm	d ₅ mm	L ₁ mm	L ₂ mm	L ₃ mm	Filetage à droite right hand thread N° article stock no.	Filetage à gauche left hand thread N° article stock no.
3	M 5	6,3	3,3	5,5	73	18	50	311 016 005	311 017 005
4	M 6	7,5	4,3	6,4	89	24	60	311 016 006	311 017 006
5	M 8	9,0	5,3	7,8	98	30	60	311 016 008	311 017 008
6	M 10	12,5	6,3	10,8	124	36	80	311 016 010	311 017 010
8	M 12	16,0	8,3	14,0	165	55	100	311 016 012	311 017 012
10	M 16	17,8	10,5	15,5	202	70	120	311 016 016	311 017 016



ASS Super-Mini-Terminaison simple
filetage à droite ou à gauche

ASS Threaded Terminal, Super-Mini type
with right and left hand thread

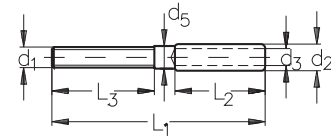

DBP

Ø câble rope-Ø mm	Filetage thread d ₁	d ₂ mm	d ₃ mm	d ₅ mm	L ₁ mm	L ₂ mm	L ₃ mm	Filetage à droite right hand thread N° article stock no.	Filetage à gauche left hand thread N° article stock no.
2	M 3	4,5	2,2	4,0	35	15	15	321 010 003	321 011 003
3	M 4	5,4	3,3	4,6	45	20	20	321 010 004	321 011 004
4	M 5	6,5	4,3	5,5	52	22	25	321 010 005	321 011 005
5	M 6	7,5	5,3	6,4	63	25	30	321 010 006	321 011 006
6	M 8	9,0	6,3	7,8	68	30	30	321 010 008	321 011 008
8	M 10	12,5	8,5	10,8	88	40	40	321 010 010	321 011 010



ASS Super-Mini-Terminaison simple
filetage long à droite ou à gauche

ASS Threaded Terminal, Super-Mini type
with extra long thread, right and left hand

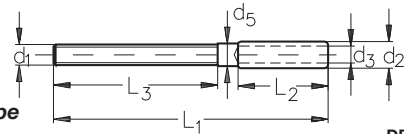

DBP

Ø câble rope-Ø mm	Filetage thread d ₁	d ₂ mm	d ₃ mm	d ₅ mm	L ₁ mm	L ₂ mm	L ₃ mm	Filetage à droite right hand thread N° article stock no.	Filetage à gauche left hand thread N° article stock no.
3	M 4	5,4	3,3	4,6	65	20	40	321 012 004	321 013 004
4	M 5	6,5	4,3	5,5	77	22	50	321 012 005	321 013 005
5	M 6	7,5	5,3	6,4	93	25	60	321 012 006	321 013 006
6	M 8	9,0	6,3	7,8	98	30	60	321 012 008	321 013 008
8	M 10	12,5	8,5	10,8	128	40	80	321 012 010	321 013 010

Note : la cote d₅ des Terminaisons KW et des Super-Mini correspond au diamètre après sertissage, d'où absence de bourrelet.

d₅ corresponds for type KW and Super-Mini- type to the diameter after swaging, therefore the shaft is without bulge (see photo). d₅ does not correspond to the diameter of the bore whole in the posts. **The responsible swaging company will give you the required details.**

Sans précision, les articles ci-dessus seront livrés filetés à droite.

All items are delivered with right hand thread unless specified otherwise.



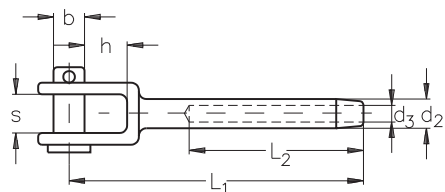

Terminaison à chape INOX standard

NIRO Jaw Terminal Standard type

Ø câble rope-Ø mm	d ₂ mm	d ₃ mm	L ₁ mm	L ₂ mm	h mm	s mm	b mm	N° article stock no.
3	6,3	3,3	67	38	8,5	7	6,0	301 020 003
4	7,5	4,3	76	45	11	10	7,9	301 020 004
5	9,0	5,3	85	52	13	12	9,0	301 020 005
6	12,5	6,3	108	63	22	13	12,0	301 020 006
7	14,2	7,3	114	70	22	14	12,5	301 020 007
8	16,0	8,3	146	80	22	15	14,9	301 020 008
10	17,8	10,5	153	90	24	18	15,9	301 020 010

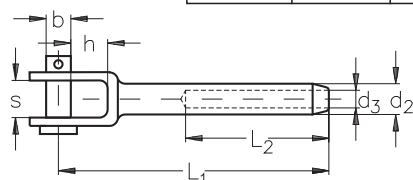

ASS Mini-Terminaison à chape

ASS Jaw Terminal, Mini type

DBGM

Ø câble rope-Ø mm	d ₂ mm	d ₃ mm	L ₁ mm	L ₂ mm	h mm	s mm	b mm	N° article stock no.
3	6,3	3,3	56	27	9	7	5	311 020 003
4	7,5	4,3	64	35	8	8	6	311 020 004
5	9,0	5,3	71	40	11	11	8	311 020 005
6	12,5	6,3	86	50	13	12	9	311 020 006

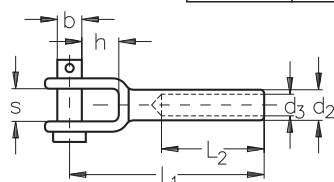

ASS Super-Mini-Terminaison à chape

ASS Jaw Terminal, Super-Mini type

DBP

Ø câble rope-Ø mm	d ₂ mm	d ₃ mm	L ₁ mm	L ₂ mm	h mm	s mm	b mm	N° article stock no.
3	5,5	3,5	45	20	9,5	7,5	5	321 020 003
4	6,3	4,4	45	22	9,5	7,5	5	321 020 004
5	7,5	5,3	52	25	10,0	10,0	6	321 020 005
6	9,0	6,5	58	30	11,0	11,0	8	321 020 006

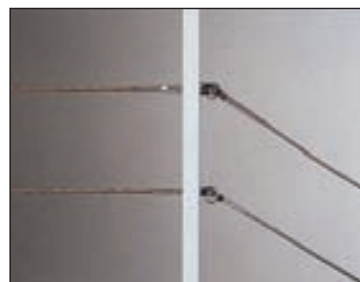

ASS Mini-Terminaison à tête fraisée
ASS Cone Terminal, Mini type
DBGM

Ø câble rope-Ø mm	d ₁ mm	d ₂ mm	d ₃ mm	L ₁ mm	L ₂ mm	h mm	N° article stock no.
3	8,0	6,3	3,3	34	27	2	311 030 003
4	9,5	7,5	4,3	43	35	2	311 030 004
5	13,0	9,0	5,3	50	40	3	311 030 005
6	16,5	12,5	6,3	64	50	3	311 030 006

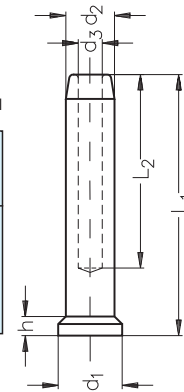

ASS Super-Mini-Terminaison à tête fraisée
ASS Cone Terminal, Super-Mini type
DBP

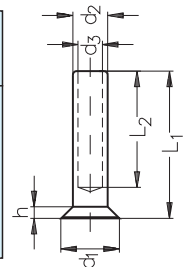
Ø câble rope-Ø mm	d ₁ mm	d ₂ mm	d ₃ mm	L ₁ mm	L ₂ mm	h mm	N° article stock no.
2	7,6	4,5	2,2	21,0	15	1,7	321 030 002
3	8,7	5,4	3,3	27,0	20	2,0	321 030 003
4	10,9	6,5	4,3	29,0	22	2,5	321 030 004
5	12,5	7,5	5,3	32,5	25	3,0	321 030 005
6	15,0	9,0	6,3	38,0	30	4,0	321 030 006
8	20,0	12,5	8,5	50,0	40	5,0	321 030 008

ASS Super-Mini-Terminaison à tête bombée
ASS Dome head Terminal, Super-Mini type
DBP

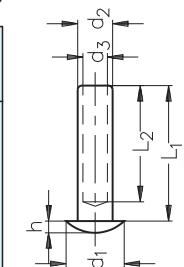
Ø câble rope-Ø mm	d ₁ mm	d ₂ mm	d ₃ mm	L ₁ mm	L ₂ mm	h mm	N° article stock no.
2	7,6	4,5	2,2	19	15	1,65	321 040 002
3	8,7	5,4	3,3	25	20	1,70	321 040 003
4	10,9	6,5	4,3	27	22	2,20	321 040 004
5	12,5	7,5	5,3	30	25	2,50	321 040 005
6	15,0	9,0	6,3	35	30	3,00	321 040 006
8	20,0	12,5	8,5	48	40	4,00	321 040 008

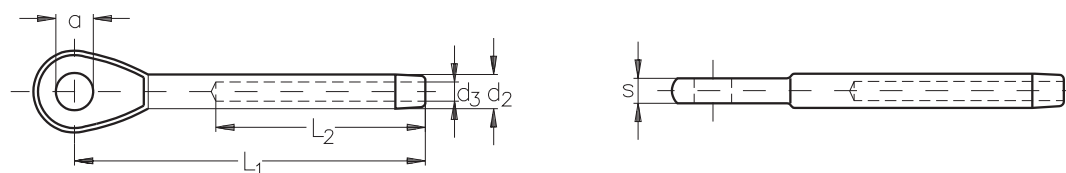



Terminaison à œil INOX standard

NIRO Eye Terminal Standard type

Ø câble rope-Ø mm	d ₂ mm	d ₃ mm	L ₁ mm	L ₂ mm	a mm	s mm	N° article stock no.
3	6,3	3,3	55	38	6,5	5,0	301 025 003
4	7,5	4,3	65	45	8,5	6,0	301 025 004
5	9,0	5,3	79	52	10,0	7,0	301 025 005
6	12,5	6,3	94	63	12,5	8,0	301 025 006
7	14,2	7,3	105	70	12,5	9,0	301 025 007
8	16,0	8,3	124	80	14,5	10,0	301 025 008
10	17,8	10,5	144	90	16,0	12,0	301 025 010

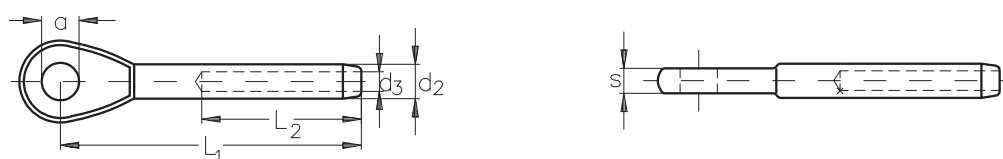

ASS Mini-Terminaison à œil

ASS Eye Terminal, Mini type

DBGM

Ø câble rope-Ø mm	d ₂ mm	d ₃ mm	L ₁ mm	L ₂ mm	a mm	s mm	N° article stock no.
3	6,3	3,3	40	18	6,5	5	311 025 003
4	7,5	4,3	52	24	8,5	6	311 025 004
5	9,0	5,3	62	30	9,5	7	311 025 005
6	12,5	6,3	75	36	13,0	8	311 025 006

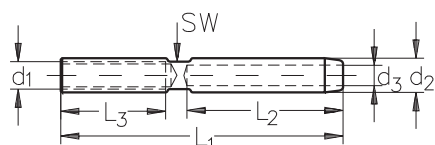

ASS Mini-Terminaison taraudée
taraudée à droite ou à gauche

ASS Threaded Terminal, Mini type
with *internal* thread, right and left hand

DBGM

Ø câble rope-Ø mm	Filetage thread d ₁	d ₂ mm	d ₃ mm	L ₁ mm	L ₂ mm	L ₃ mm	SW mm	Filetage à droite right hand thread N° article stock no.	Filetage à gauche left hand thread N° article stock no.
3	M 5	6,5	3,3	54	27	20	5	311 012 003	311 013 003
4	M 6	7,5	4,3	62	35	20	6	311 012 004	311 013 004
5	M 6	9,0	5,3	67	40	20	7	311 012 005	311 013 005
6	M 8	12,5	6,3	82	50	25	10	311 012 006	311 013 006
8	M 10	16,0	8,3	106	60	40	14	311 012 008	311 013 008

Sans précision, les mini-terminaisons taraudées ci-dessus seront livrées filetées à droite.
The ASS Threaded terminals, Mini type, with internal thread are delivered with right hand thread unless specified otherwise.

Balustrades en câbles Inox

Les balustrades sont des équipements de sécurité qui doivent protéger des chutes verticales. Les poteaux, mains courantes et hauteurs de balustrades sont calculés de telle façon à ce que personne ne puisse se blesser. La disposition des câbles doit rendre impossible le passage entre eux ainsi que l'enjambement d'un enfant.

Ballustrading made from stainless steel ropes

Ballustrading is a security measure to protect falling. Posts, handrails and the height of the ballustrade should guarantee the safety of everyone. Infill ropes must ensure no one can fall through and infants can not over-climb them.



ASS Terminaison à vis



ASS Screw terminal for self assembly



DBGM

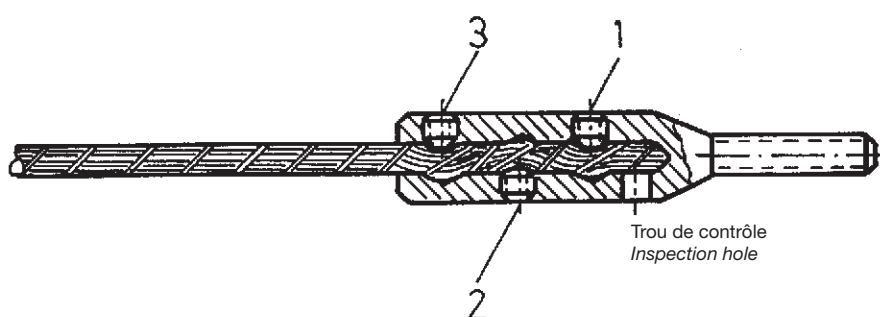

Note importante concernant les ASS terminaisons à vis montage manuel

Notre terminaison à vis, montage manuel est adaptée lorsque, sur un site extérieur la longueur des câbles n'a pu être déterminée avec précision.

Dans d'autres cas aussi, lorsque dans le domaine privé, par exemple, les câbles doivent être adaptés individuellement et les raccordements assemblés manuellement.

Dans tous ces cas, notre ASS Terminaison à vis, montage manuel, offre la meilleure solution pour les câbles de 2, 3 et 4 mm.

Les câbles ne doivent cependant pas être soumis à des charges trop importantes. Dans quelle mesure la tension du câble peut être sollicitée, dépend du soin apporté au montage. Il faut, en tous cas, minorer les charges en comparaison d'une terminaison sertie.

Pour le montage, le câble doit être poussé dans la terminaison jusqu'à ce qu'il apparaisse dans le trou de contrôle. Les vis seront serrées dans l'ordre 1, 2 et 3 (voir illustration). Grâce à cet assemblage, le câble, dans la terminaison, prendra la forme d'une courbe sinusoidale. Veillez à bien vérifier que l'extrémité du câble, après avoir serré les vis soit toujours visible dans le trou de contrôle.

Important notes for the ASS Self Assembly Screw terminal, Standard and Mini type

Our ASS Self Assembly Screw terminals are designed for fitting on-site when exact dimensions are not available in advance.

The ASS Self Assembly Screw terminals for wire ropes 2, 3 and 4 mm diameter are suitable for use by the non-professional but care must be taken with the fitting to the wire rope in order to achieve an acceptable capacity for the completed ropes.

Designed by our company and protected by DBGM the ASS Self Assembly Screw terminals are assembled on the rope by employing three threaded studs arranged in a radial direction at 180° to each other. By tightening the studs the rope is compressed and takes on the shape of a sinus curve inside the terminal.

Our break tests have indicated that the sinus curve gives a 50 % higher breaking load of the rope when compared to passing the rope through the fitting parallel. We employed a torque key and tightened the studs to 5 Nm for our tests and recommend the same procedure is used in the field.

The rope should be inserted into the terminal until it is visible through the inspection hole and studs should be tightened in order 1, 2, 3 as above instructions (see drawing).

The efficiency rating of these self assembly screw terminals is not as high as swaged or pressed terminals and therefore the total capacity of the rope must be reduced to cater for this.



ASS Mini-Terminaison à vis à tige filetée droite ou gauche montage manuel

ASS Screw terminal, Mini type with outside thread, right and left hand for self assembly

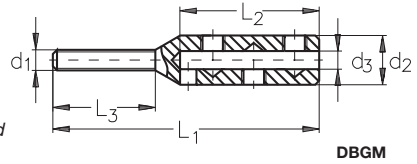

Désignation nominal size	Ø câble rope-Ø mm	Filetage thread d ₁	d ₂ mm	d ₃ mm	L ₁ mm	L ₂ mm	L ₃ mm	Filetage à droite right hand thread N° article stock no.	Filetage à gauche left hand thread N° article stock no.
2	2	M 4	8	2,4	50	25	20	331 010 002	331 012 002
3	3	M 4	10	3,5	56	32	20	331 010 003	331 012 003
4	4	M 5	12	4,5	65	34	25	331 010 004	331 012 004

Construction des câbles :
7 x 7 suivant DIN 3055
7 x 19 suivant DIN 3060

Rope constructions:
7 x 7 according to DIN 3055
7 x 19 according to DIN 3060

ASS Mini-Terminaison à vis taraudée droite ou gauche montage manuel

ASS Screw terminal, Mini type with internal thread, right and left hand for self assembly

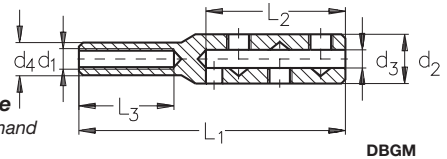

Désignation nominal size	Ø câble rope-Ø mm	Filetage thread d ₁	d ₂ mm	d ₃ mm	d ₄ mm	L ₁ mm	L ₂ mm	L ₃ mm	Filetage à droite right hand thread N° article stock no.	Filetage à gauche left hand thread N° article stock no.
2	2	M 4	8	2,4	6	50	25	20	331 210 002	331 212 002
3	3	M 4	10	3,5	6	56	32	20	331 210 003	331 212 003
4	4	M 5	12	4,5	8	65	34	25	331 210 004	331 212 004

Construction des câbles :
7 x 7 suivant DIN 3055
7 x 19 suivant DIN 3060

Rope constructions:
7 x 7 according to DIN 3055
7 x 19 according to DIN 3060

ASS Mini-Terminaison à vis à œil, montage manuel

ASS Screw terminal, Mini type with eye for self assembly

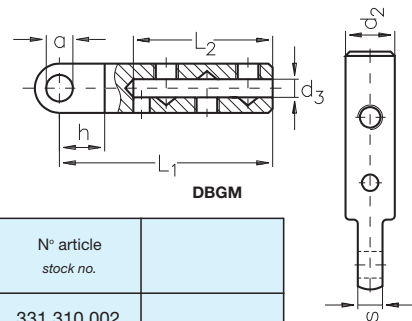

Désignation nominal size	Ø câble rope-Ø mm	d ₂ mm	d ₃ mm	L ₁ mm	L ₂ mm	a mm	s mm	h mm	N° article stock no.
2	2	8	2,4	37	25	4,5	4	9	331 310 002
3	3	10	3,5	43	32	5,5	5	11	331 310 003
4	4	12	4,5	52	34	6,5	6	11	331 310 004

Construction des câbles :
7 x 7 suivant DIN 3055
7 x 19 suivant DIN 3060

Rope constructions:
7 x 7 according to DIN 3055
7 x 19 according to DIN 3060

ASS Mini-Terminaison à vis à chape, montage manuel

ASS Screw terminal, Mini type with jaw for self assembly

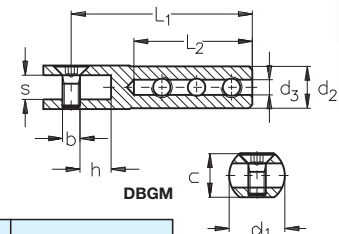

Désignation nominal size	Ø câble rope-Ø mm	c mm	d ₁ mm	d ₂ mm	d ₃ mm	L ₁ mm	L ₂ mm	s mm	h mm	b	N° article stock no.
2	2	10,0	12	8	2,4	37	25	4,5	7	M 4	331 410 002
3	3	10,5	13	10	3,5	50	32	5,5	9	M 4	331 410 003
4	4	12,5	16	12	4,5	52	34	6,5	9	M 5	331 410 004

Construction des câbles :
7 x 7 suivant DIN 3055
7 x 19 suivant DIN 3060

Rope constructions:
7 x 7 according to DIN 3055
7 x 19 according to DIN 3060

ASS Terminaison taraudée à droite montage manuel

ASS Screw terminal with right hand thread for self assembly

Trou de contrôle inspection hole

DBGM

Désignation nominal size	Ø câble rope-Ø mm	d ₁	d ₂ mm	d ₃ mm	L ₁ mm	L ₂ mm	L ₃ mm	N° article stock no.
4	3 + 4	M 6	12	4,5	70	40	25	331 510 004

Construction des câbles :
7 x 7 suivant DIN 3055
7 x 19 suivant DIN 3060

Rope constructions:
7 x 7 according to DIN 3055
7 x 19 according to DIN 3060

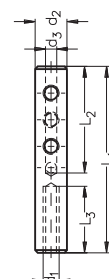

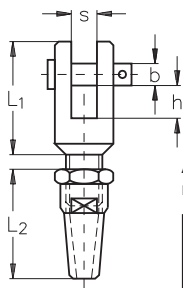

ASS Terminaison à chape
montage manuel

ASS Jaw terminal
for self assembly

Désignation nominal size	Ø câble rope-Ø mm	L ₁ mm	L ₂ mm	h mm	s mm	b mm	N° article stock no.
3	3	28	29	14	4,8	5	331 610 003
4	4	31	31	9	7	6	331 610 004
5	5	37	36	12	8	8	331 610 005
6	6	39	49	14	10	8	331 610 006
8	8	49	47	17	12	10	331 610 008
10	10	55	64	15	11	12	331 610 010
12	12	72	75	23	18	19	331 610 012

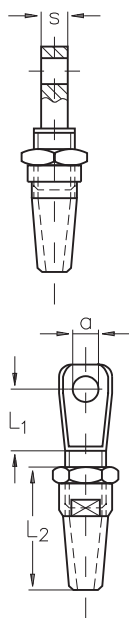

ASS Terminaison à œil
montage manuel

ASS Eye terminal
for self assembly

Désignation nominal size	Ø câble rope-Ø mm	L ₁ mm	L ₂ mm	a mm	s mm	N° article stock no.
3	3	21	29	5	5	331 620 003
4	4	22	31	6	7	331 620 004
5	5	36	36	8	8	331 620 005
6	6	36	50	11	9	331 620 006
8	8	27	47	15	11	331 620 008
10	10	40	64	16	11	331 620 010
12	12	44	75	19	19	331 620 012

ASS Terminaison à tige filetée
filetage à droite, montage manuel

ASS Threaded Terminal with outside thread
for self assembly, right hand thread

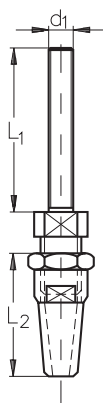

Désignation nominal size	Ø câble rope-Ø mm	d ₁	L ₁ mm	L ₂ mm	N° article stock no.
3	3	M 6	40	29	331 710 003
4	4	M 8	50	31	331 710 004
5	5	M 10	66	36	331 710 005
6	6	M 12	72	49	331 710 006

n'existe pas avec filetage à gauche

ASS Terminaison conique taraudée à droite
montage manuel

ASS Threaded Terminal with internal thread
for self assembly, right hand thread

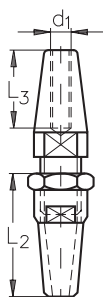

Désignation nominal size	Ø câble rope-Ø mm	d ₁	L ₂ mm	L ₃ mm	N° article stock no.
3	3	M 5	29	15	331 720 003
4	4	M 6	31	15	331 720 004
5	5	M 8	36	20	331 720 005
6	6	M 8	49	20	331 720 006

n'existe pas avec taraudage à gauche

Instructions d'assemblage pour ASS Terminaison à chape, à œil et à tige filetée ou taraudée.
Assembly instructions for ASS Jaw terminal, ASS Eye terminal and ASS Threaded terminal



Dans un premier temps, il faut dévisser la terminaison à chape ou à œil, taraudée ou filetée.
 A l'intérieur, se trouvent deux clavettes : la clavette est de couleur jaune pour les constructions de câble 7 x 7 et 7 x 19 la clavette est de couleur blanche pour les constructions de câble 1 x 19

L'extrémité du câble doit être glissée dans la partie conique. Séparez à l'aide d'un objet les fils extérieurs de façon à laisser apparaître la partie intérieure (voir illustration)

La clavette doit être positionnée à l'intérieur de la rainure et doit se terminer à environ 1 à 2 mm au-dessus de l'extrémité du cône.
 Les câbles extérieurs doivent être vrillés autour de la clavette de façon régulière. Assembler et visser les deux parties à l'aide de deux clés.

Assembly instructions for ASS Jaw terminal, ASS Eye terminal and ASS Threaded terminal

First unscrew the jaw/eye/threaded terminal.

Inside you will find two cones, one coloured yellow for 7 x 7 and 7 x 19 construction ropes and one coloured white for 1 x 19 construction ropes. Slide the screwed end over the rope, then unlay the outer wires to expose the core. The cone should be fed over the core and the outer wires laid back over it (see drawing). The core should be laid in the groove and should end about 1-2 mm higher than the top edge of the cone. Assembly of the fitting can now take place by screwing both halves firmly together using a vice or two spanners.

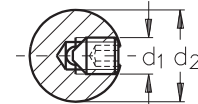
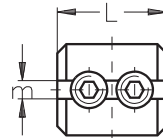

ASS Manchon Serre-câble

ASS Cylindrical rope clip

DBGM Design protégé registered design

Désignation nominal size	Ø câble rope-Ø mm	m mm	d ₁	d ₂ mm	L mm	N° article stock no.
4	3 + 4	4,2	M 8	20	24	391 510 004
6	5 + 6	6,2	M 10	28	32	391 510 006

Utilisable que pour des constructions de câbles 7 x 7 et 7 x 19.
 Only applicable for rope constructions 7 x 7 and 7 x 19.

Pince coupante pour câble

Wire rope cutters

Désignation nominal size	recommandé pour diamètre câble maxi recommended for ropes up to diameter mm	N° article stock no.
7	4	392 010 007
9	6	392 010 009

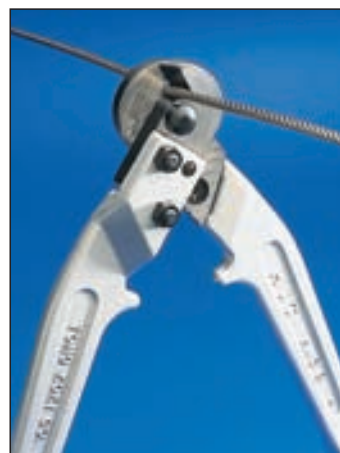



UN diamètre câble - **TROIS** générations de ridoirs
One rope diameter - **Three** Rigging screw options

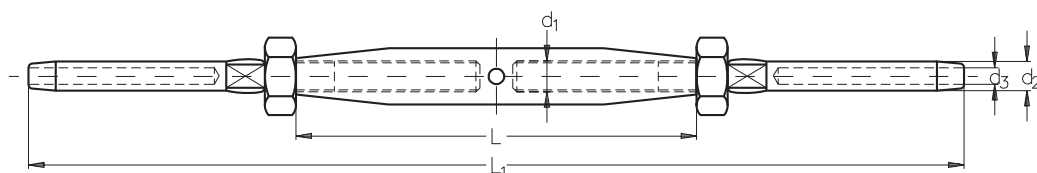

Ridoir INOX
à deux terminaisons simples
standard

NIRO Rigging Screw
with terminal and terminal
Standard type

Ø câble rope-Ø mm	Filetage thread d ₁	d ₂ mm	d ₃ mm	L mm	L ₁ mm	N° article stock no.	
2,5	M 5	5,4	2,7	80	178	301 210 005	
3	M 6	6,3	3,3	95	203	301 210 006	
4	M 8	7,5	4,3	105	225	301 210 008	
5	M 10	9,0	5,3	125	260	301 210 010	
6	M 12	12,5	6,3	150	335	301 210 012	
8	M 16	16,0	8,3	190	440	301 210 016	
10	M 20	17,8	10,5	210	570	301 210 020	

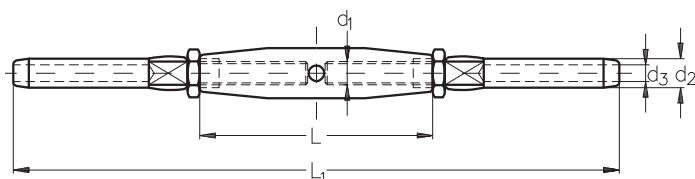

ASS Mini-Ridoir
à deux terminaisons simples

ASS Rigging Screw, Mini type
with terminal and terminal

DBGM design protégé
registered design

Ø câble rope-Ø mm	Filetage thread d ₁	d ₂ mm	d ₃ mm	L mm	L ₁ mm	N° article stock no.	
3	M 5	6,3	3,3	50	123	311 210 005	
4	M 6	7,5	4,3	60	158	311 210 006	
5	M 8	9,0	5,3	60	169	311 210 008	
6	M 10	12,5	6,3	80	220	311 210 010	

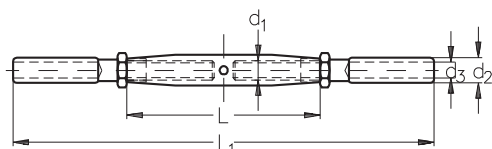

ASS Super-Mini-Ridoir
à deux terminaisons simples

ASS Rigging Screw, Super-Mini type
with terminal and terminal

DBGM design protégé
registered design

Ø câble rope-Ø mm	Filetage thread d ₁	d ₂ mm	d ₃ mm	L mm	L ₁ mm	N° article stock no.	
3	M 4	5,4	3,3	40	96	321 210 004	
4	M 5	6,5	4,3	50	110	321 210 005	
5	M 6	7,5	5,3	60	134	321 210 006	
6	M 8	9,0	6,3	60	142	321 210 008	

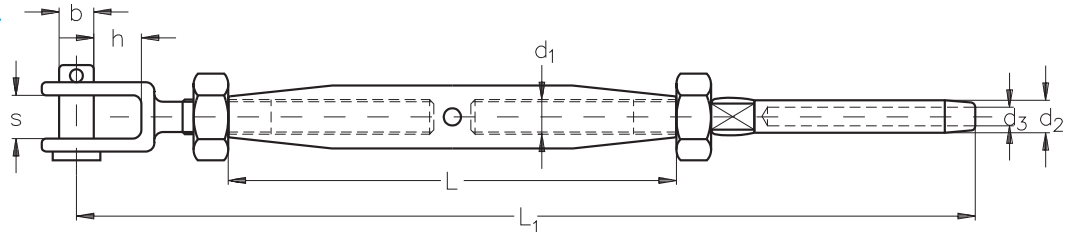

Ridoir INOX

à chape fileté à gauche et terminaison à sertir standard

NIRO Rigging Screw
with jaw and terminal
Standard type

Ø câble rope-Ø mm	Filetage thread d ₁	d ₂ mm	d ₃ mm	h mm	s mm	b mm	L mm	L ₁ mm	N° article stock no.
2,5	M 5	5,4	2,7	9	6	5,0	80	150	301 211 005
3	M 6	6,3	3,3	8,5	7	6,0	95	175	301 211 006
4	M 8	7,5	4,3	11	10	8,0	105	200	301 211 008
5	M 10	9,0	5,3	13	12	9,0	125	225	301 211 010
6	M 12	12,5	6,3	21	13	12,0	150	280	301 211 012
7	M 14	14,2	7,3	22	14	14,0	165	320	301 211 014
8	M 16	16,0	8,3	26	17	16,0	190	390	301 211 016
10	M 20	17,8	10,5	29	20	19,0	210	415	301 211 020

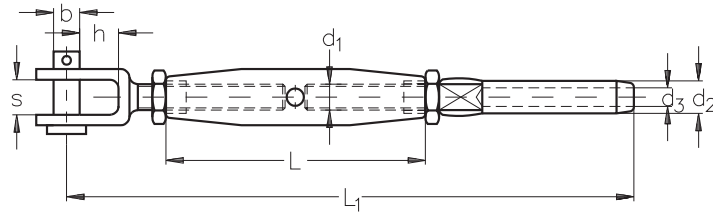

ASS Mini-Ridoir

à chape fileté à gauche et terminaison simple

ASS Rigging Screw, Mini type
with jaw and terminal

DBGM design protégé
registered design

Ø câble rope-Ø mm	Filetage thread d ₁	d ₂ mm	d ₃ mm	h mm	s mm	b mm	L mm	L ₁ mm	N° article stock no.
3	M 5	6,3	3,3	9	7	5	50	107	311 211 005
4	M 6	7,5	4,3	8	8	6	60	133	311 211 006
5	M 8	9,0	5,3	11	11	8	60	142	311 211 008
6	M 10	12,5	6,3	13	12	9	80	190	311 211 010

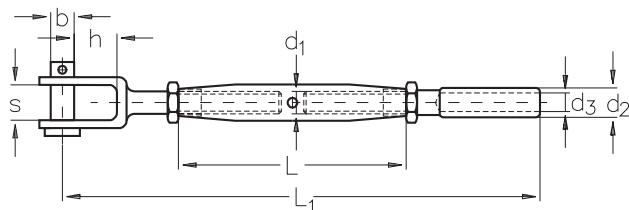

ASS Super-Mini-Ridoir

à chape fileté à gauche et terminaison simple

ASS Rigging Screw, Super-Mini type
with jaw and terminal

DBGM design protégé
registered design

Ø câble rope-Ø mm	Filetage thread d ₁	d ₂ mm	d ₃ mm	h mm	s mm	b mm	L mm	L ₁ mm	N° article stock no.
3	M 4	5,4	3,3	9	7	5	40	88	321 211 004
4	M 5	6,5	4,3	9	7	5	50	102	321 211 005
5	M 6	7,5	5,3	8	8	6	60	118	321 211 006
6	M 8	9,0	6,3	11	11	8	60	130	321 211 008



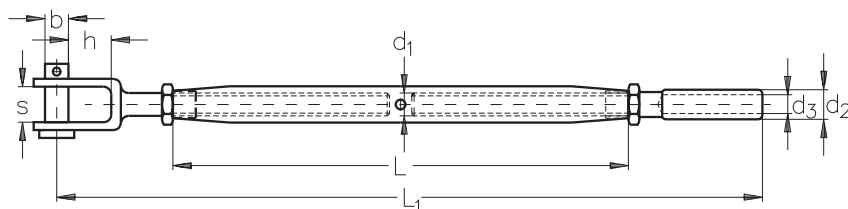

ASS Super-Mini-Ridoir
à chape filetée à gauche et terminaison, **cage longue**

ASS Rigging Screw, Super-Mini type
with jaw and terminal, **long type**

DBGM design protégé
registered design

Ø câble rope-Ø mm	Filetage thread d ₁	d ₂ mm	d ₃ mm	h mm	s mm	b mm	L mm	L ₁ mm	N° article stock no.
3	M 4	5,4	3,3	9	7	5	80	130	321 221 004
4	M 5	6,5	4,3	9	7	5	100	153	321 221 005
5	M 6	7,5	5,3	9	8	6	120	182	321 221 006
6	M 8	9,0	6,3	11	11	8	120	193	321 221 008

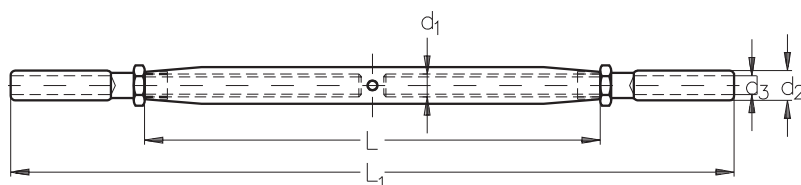

ASS Super-Mini-Ridoir
à deux terminaisons, **cage longue**

ASS Rigging Screw, Super-Mini type
with terminal and terminal, **long type**

DBGM design protégé
registered design

Ø câble rope-Ø mm	Filetage thread d ₁	d ₂ mm	d ₃ mm	L mm	L ₁ mm	N° article stock no.
3	M 4	5,4	3,3	80	135	321 220 004
4	M 5	6,5	4,3	100	160	321 220 005
5	M 6	7,5	5,3	120	193	321 220 006
6	M 8	9,0	6,3	120	204	321 220 008

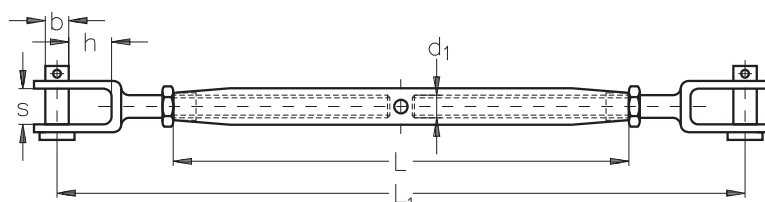

ASS Super-Mini-Ridoir
à deux chapes, **cage longue**

ASS Rigging Screw, Super-Mini type
with jaw and jaw, **long type**

Désignation nominal size	Filetage thread d ₁	h mm	s mm	b mm	L mm	L ₁ mm	N° article stock no.
M 4	M 4	9	7	5	80	125	321 222 004
M 5	M 5	9	7	5	100	146	321 222 005
M 6	M 6	9	8	6	120	171	321 222 006
M 8	M 8	11	11	8	120	182	321 222 008

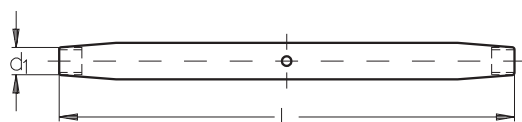

ASS Super-Mini-Cage de ridoir
cage longue

ASS Rigging Screw, Super-Mini type
body only, long type

Désignation nominal size	d ₁	L mm	N° article stock no.
M 4	M 4	80	321 223 004
M 5	M 5	100	321 223 005
M 6	M 6	120	321 223 006
M 8	M 8	120	321 223 008
M 10	M 10	160	321 223 010

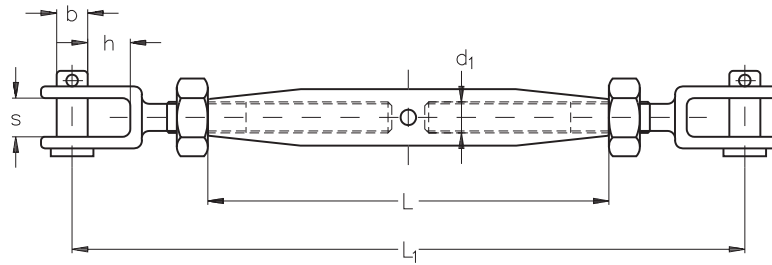

Ridoir INOX
à deux chapes
standard

NIRO Rigging Screw
with jaw and jaw
Standard type

Désignation nominal size	Filetage thread d ₁	h mm	s mm	b mm	L mm	L ₁ mm	N° article stock no.
M 5	M 5	9	6	5,0	80	120	301 212 005
M 6	M 6	8,5	7	6,0	95	145	301 212 006
M 8	M 8	11	10	8,0	105	165	301 212 008
M 10	M 10	13	12	9,0	125	195	301 212 010
M 12	M 12	21	13	12,0	150	245	301 212 012
M 14	M 14	22	14	14,0	165	270	301 212 014
M 16	M 16	26	17	16,0	190	325	301 212 016
M 20	M 20	29	20	19,0	210	380	301 212 020

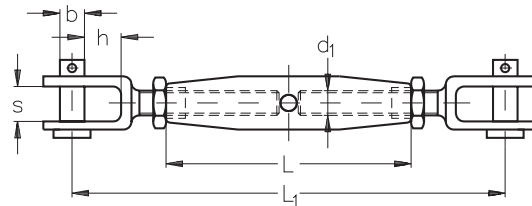

ASS Mini-Ridoir
à deux chapes

ASS Rigging Screw, Mini type
with jaw and jaw

Désignation nominal size	Filetage thread d ₁	h mm	s mm	b mm	L mm	L ₁ mm	N° article stock no.
M 4	M 4	9	7	5	40	80	311 212 004
M 5	M 5	9	7	5	50	92	311 212 005
M 6	M 6	8	8	6	60	105	311 212 006
M 8	M 8	11	11	8	60	120	311 212 008
M 10	M 10	13	12	9	80	152	311 212 010



Cage de Ridoir INOX
standard

NIRO Rigging Screw - body
Standard type

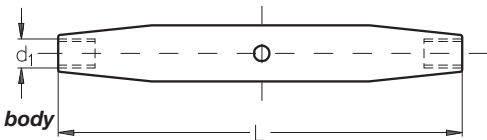

Désignation nominal size	Filetage thread d ₁	L mm	N° article stock no.
M 5	M 5	80	301 213 005
M 6	M 6	95	301 213 006
M 8	M 8	105	301 213 008
M 10	M 10	125	301 213 010
M 12	M 12	150	301 213 012
M 16	M 16	190	301 213 016
M 20	M 20	210	301 213 020

ASS Cage de Ridoir
pour Mini et Super-Mini

ASS Rigging Screw - body
for Mini and Super-Mini type

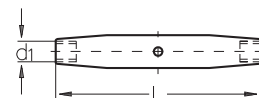

Désignation nominal size	Filetage thread d ₁	L mm	N° article stock no.
M 4	M 4	40	311 213 004
M 5	M 5	50	311 213 005
M 6	M 6	60	311 213 006
M 8	M 8	60	311 213 008
M 10	M 10	80	311 213 010

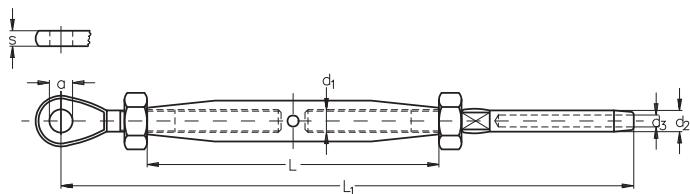

Ridoir INOX
à œil et terminaison simple
standard

NIRO Rigging Screw
with eye and terminal
Standard type

Ø câble rope-Ø mm	Filetage thread d ₁	d ₂ mm	d ₃ mm	a mm	s mm	L mm	L ₁ mm	N° article stock no.
2,5	M 5	5,4	2,7	5,5	3	80	156	301 214 005
3	M 6	6,3	3,3	6,5	4	95	168	301 214 006
4	M 8	7,5	4,3	8,5	5	105	200	301 214 008
5	M 10	9,0	5,3	10,5	6	125	234	301 214 010
6	M 12	12,5	6,3	13,0	8	150	280	301 214 012
8	M 16	16,0	8,3	14,5	10	190	362	301 214 016
10	M 20	17,8	10,5	19,5	15	215	405	301 214 020

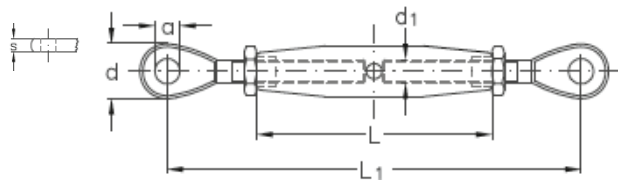

ASS Mini-Ridoir
à 2 œils

ASS Rigging Screw, Mini type
with eye and eye

DBGM

Ø câble rope-Ø mm	Filetage thread d ₁	d mm	a mm	s mm	L mm	L ₁ mm	N° article stock no.
3	M 5	12	5,5	3	50	106	311 218 105
4	M 6	13,5	6,5	4	60	109	311 218 106
5	M 8	17,5	8,5	5	60	123	311 218 108
6	M 10	22	10,5	6	80	138	311 218 110

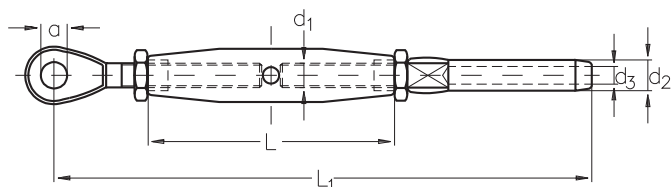

ASS Mini-Ridoir
à œil et terminaison simple

ASS Rigging Screw, Mini type
with eye and terminal

DBGM

Ø câble rope-Ø mm	Filetage thread d ₁	d ₂ mm	d ₃ mm	a mm	s mm	L mm	L ₁ mm	N° article stock no.
3	M 5	6,3	3,3	5,5	3	50	111	311 214 005
4	M 6	7,5	4,3	6,5	4	60	130	311 214 006
5	M 8	9,0	5,3	8,5	5	60	139	311 214 008
6	M 10	12,5	6,3	10,5	6	80	181	311 214 010

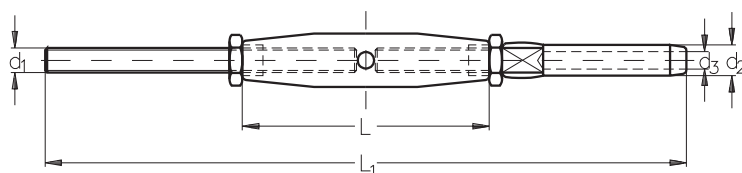

ASS Mini-Ridoir
à tige filetée et terminaison simple

ASS Rigging Screw, Mini type
with threaded rod and terminal

DBGM

Ø câble rope-Ø mm	Filetage thread d ₁	d ₂ mm	d ₃ mm	L mm	L ₁ mm	N° article stock no.
3	M 5	6,3	3,3	50	124	311 217 005
4	M 6	7,5	4,3	60	152	311 217 006
5	M 8	9,0	5,3	60	168	311 217 008
6	M 10	12,5	6,3	80	215	311 217 010

Les ridoirs ci-dessus sont présentés avec une terminaison simple filetée à gauche, alors que la terminaison à œil ainsi que la tige filetée sont filetées à droite.

The above Rigging screws are assembled with left hand threaded terminals. The eye and rod end fittings are threaded right hand.

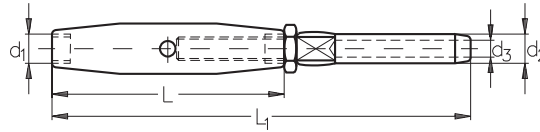

ASS Mini-Ridoir
à terminaison simple (filetée à gauche)

ASS Rigging Screw, Mini type
with one terminal (left hand thread)

DBGM

Désignation nominal size	Ø câble rope-Ø mm	Filetage thread d ₁	d ₂ mm	d ₃ mm	L mm	L ₁ mm	N° article stock no.
M 5	3	M 5	6,3	3,3	50	86	311 215 005
M 6	4	M 6	7,5	4,3	60	109	311 215 006
M 8	5	M 8	9,0	5,3	60	115	311 215 008
M 10	6	M 10	12,5	6,3	80	150	311 215 010

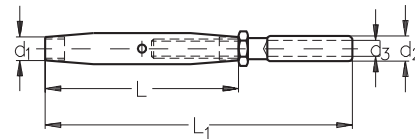

ASS Super-Mini-Ridoir
à terminaison simple (filetée à gauche)

ASS Rigging Screw, Super-Mini type
with one terminal (left hand thread)

DBGM

Désignation nominal size	Ø câble rope-Ø mm	Filetage thread d ₁	d ₂ mm	d ₃ mm	L mm	L ₁ mm	N° article stock no.
M 4	3	M 4	5,4	3,3	40	68	321 215 004
M 5	4	M 5	6,5	4,3	50	80	321 215 005
M 6	5	M 6	7,5	5,3	60	97	321 215 006
M 8	6	M 8	9,0	6,3	60	102	321 215 008

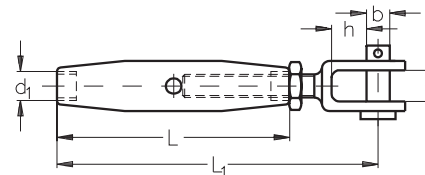

ASS Mini-Ridoir
à chape (filetée à gauche)

ASS Rigging Screw, Mini type
with one jaw (left hand thread)

Désignation nominal size	Filetage thread d ₁	h mm	s mm	b mm	L mm	L ₁ mm	N° article stock no.
M 4	M 4	9	7	5	40	60	311 216 004
M 5	M 5	9	7	5	50	71	311 216 005
M 6	M 6	8	8	6	60	81	311 216 006
M 8	M 8	11	11	8	60	88	311 216 008
M 10	M 10	13	12	9	80	123	311 216 010

Les ridoirs ci-dessus sont présentés avec une terminaison simple filetée à gauche. L'autre extrémité est filetée à droite. Elle est libre de recevoir la terminaison de votre choix, telle que vis, tige filetée, etc.

The above Rigging screws are supplied with one terminal, other end is screwed right hand to facilitate the use of terminals of your choice i. e. threaded rods, screws etc.

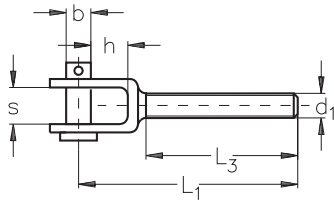

ASS Mini-Tige filetée à chape
filetage à droite ou à gauche

ASS Threaded Jaw, Mini type
with right and left hand thread

Désignation nominal size	Filetage thread d ₁	L ₁ mm	L ₃ mm	h mm	s mm	b mm	Filetage à droite right hand thread N° article stock no.	Filetage à gauche left hand thread N° article stock no.
M 4	M 4	40	20	9	7	5	311 520 004	311 521 004
M 5	M 5	45	25	9	7	5	311 520 005	311 521 005
M 6	M 6	52	30	8	8	6	311 520 006	311 521 006
M 8	M 8	57	30	11	11	8	311 520 008	311 521 008
M 10	M 10	77	40	13	12	9	311 520 010	311 521 010

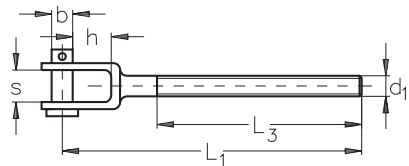

ASS Super Mini-Tige filetée à chape, tige longue
filetage à droite ou à gauche

ASS Threaded Jaw, Super-Mini type, long
with right and left hand thread

Désignation nominal size	Filetage thread d ₁	h mm	s mm	b mm	L ₁ mm	L ₃ mm	Filetage à droite right hand thread N° article stock no.	Filetage à gauche left hand thread N° article stock no.
M 4	M 4	9	7	5	60	40	321 520 004	321 521 004
M 5	M 5	9	7	5	70	50	321 520 005	321 521 005
M 6	M 6	9	8	6	82	60	321 520 006	321 521 006
M 8	M 8	11	11	8	87	60	321 520 008	321 521 008
M 10	M 10	13	12	9	105	78	321 520 010	321 521 010

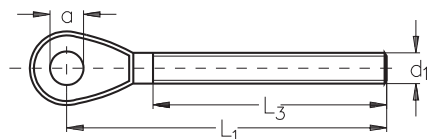

Tige filetée à œil INOX, standard
filetage à droite

NIRO Threaded Eye, Standard type
with right hand thread

Désignation nominal size d ₁	L ₁ mm	L ₃ mm	a mm	s mm	N° article stock no.
M 5	63	41	5,5	3	301 510 005
M 6	61	47	6,5	4	301 510 006
M 8	78	57	8,5	5	301 510 008
M 10	89	63	10,5	6	301 510 010
M 12	107	80	13,0	8	301 510 012
M 16	134	100	14,5	10	301 510 016
M 20	162	120	19,5	15	301 510 020

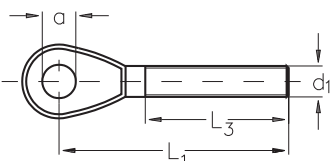

ASS Mini-Tige filetée à œil
filetage à droite ou à gauche

ASS Threaded Eye, Mini type
with right and left hand thread

Désignation nominal size d ₁	L ₁ mm	L ₃ mm	a mm	s mm	Filetage à droite right hand thread N° article stock no.	Filetage à gauche left hand thread N° article stock no.
M 5	47	25	5,5	3	311 510 005	311 511 005
M 6	48	30	6,5	4	311 510 006	311 511 006
M 8	56	35	8,5	5	311 510 008	311 511 008
M 10	66	40	10,5	6	311 510 010	311 511 010

Sans précision, les articles ci-dessus seront livrés filetés à droite.
All items are delivered with right hand thread unless specified otherwise.

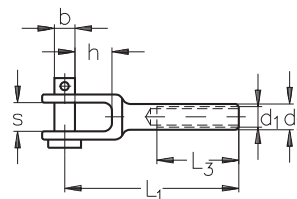

ASS Mini-Chape taraudée
taraudée à droite ou à gauche

ASS Jaw, Mini type
with *internal thread*, right and left hand

Désignation nominal size	d ₁	d ₂ mm	h mm	s mm	b mm	L ₁ mm	L ₃ mm	Filetage à droite right hand thread N° article stock no.	Filetage à gauche left hand thread N° article stock no.
M 4	M 4	5,5	9,5	7,5	5	45	15	312 010 004	312 011 004
M 5	M 5	7,5	9,5	7,5	5	50	20	312 010 005	312 011 005
M 6	M 6	7,5	10,0	10,0	6	55	25	312 010 006	312 011 006
M 8	M 8	12,5	11,0	11,0	8	65	30	312 010 008	312 011 008

ASS Chape percée

ASS Plain Jaw

Désignation nominal size	s mm	b mm	h mm	d mm	N° article stock no.
4	8,0	6	8	4,2	391 010 004
5	11,0	8	11	5,5	391 010 005
6	12,0	9	13	6,5	391 010 006
8	14,5	12	21	8,5	391 010 008

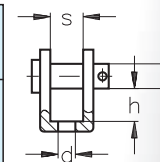

ASS Chape à émerillon
filetage à droite

ASS Swivel Jaw
with right hand thread

Désignation nominal size	d ₁	s mm	b mm	h mm	L mm	L ₃ mm	N° article stock no.
M 4	M 4	8	6	8	34	20	391 011 004
M 5	M 5	11	8	11	43	25	391 011 005
M 6	M 6	12	9	13	53	30	391 011 006
M 8	M 8	14,5	12	21	67	35	391 011 008

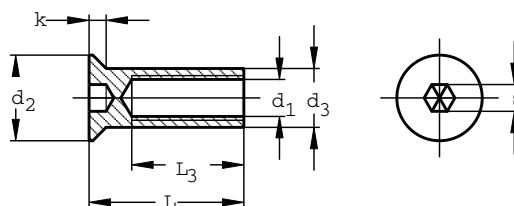
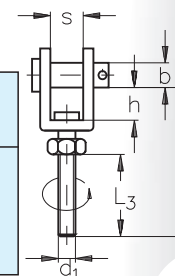

ASS Douille de tension
taraudée à droite

Désignation d ₁	L mm	L ₃ mm	k mm	d ₂ mm	d ₃ mm	s mm	N° article stock no.
M 3	15	10,5	2,0	9	5,0	3	367 010 003
M 4	15	10,5	2,0	9	5,5	3	367 010 004
M 5	29	21	2,0	10	6,6	3	367 010 005
M 6	29	21	2,7	12	8,0	4	367 010 006
M 8	29	21	3,2	16	11,0	5	367 010 008
M 10	30	21	3,7	20	14,0	6	367 010 010

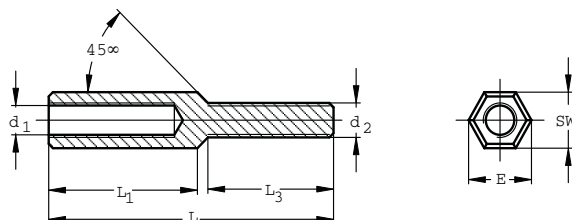

ASS Manchon de tension
taraudé à gauche et fileté à droite

Designation d ₁	L mm	L ₁ mm	L ₃ mm	d ₁ links	d ₂ rechts	SW mm	E mm	N° article stock no.	EURO/pc EURO/pc
M 3	34	15	15	M 3	M 3	7	7,7	367 000 003	
M 4	45	20	20	M 4	M 4	7	7,7	367 000 004	
M 5	55	25	25	M 5	M 5	8	8,9	367 000 005	
M 6	65	30	30	M 6	M 6	10	11,1	367 000 006	
M 8	68	30	30	M 8	M 8	13	14,4	367 000 008	
M 10	90	40	40	M 10	M 10	17	18,9	367 000 010	

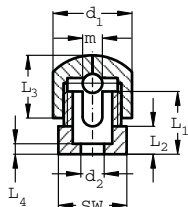

ASS Serre-câble de fixation

pour câbles 3 mm, 4 mm et 5 mm

Désignation nominal size	L ₁ mm	L ₂ mm	L ₃ mm	L ₄ mm	d ₁ mm	d ₂ mm	SW mm	m mm	N° article stock no.
5	18	8	18	3	22	6,5	19	5,5	332 010 005

ASS Serre-câble de fixation d'extrémité

adapté jusqu'au M 6

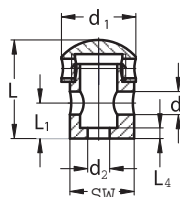

Désignation nominal size	L mm	L ₁ mm	L ₄ mm	d mm	d ₁ mm	d ₂ mm	SW mm	N° article stock no.
5	27	10	3	6,5	22	6,5	19	332 013 005

Avec les Serre-câbles de fixation d'extrémité, veuillez utiliser pour la fixation sur les terminaisons nos petits modèles de Boules ASS. Celles-ci s'appuieront sur la partie plate la plus étroite du serre-câble.

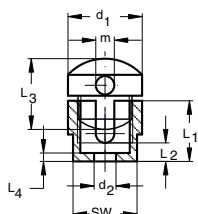

ASS Serre-câble de fixation d'angle

pour câbles 3 mm, 4 mm et 5 mm

Désignation nominal size	L ₁ mm	L ₂ mm	L ₃ mm	L ₄ mm	d ₁ mm	d ₂ mm	SW mm	m mm	N° article stock no.
5	18	5,5	21	2,5	22	6,5	19	5,5	332 017 005

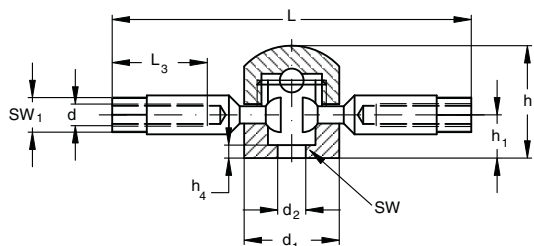

ASS Serre-câble de fixation à rotule

Désignation nominal size	L mm	L ₃ mm	h mm	h ₁ mm	h ₄ mm	d droit	d ₁ mm	d ₂ mm	SW mm	SW ₁ mm	N° article stock no.
M 5	81,5	22	26	10	3	M 5	22	6,5	19	8	332 110 005

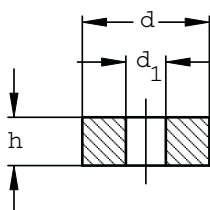

Cale d'épaisseur pour ASS Serre-câble de fixation d'angle

Désignation nominal size	d mm	d ₁ mm	h mm	N° article stock no.	EURO/pce EURO/pc
6	21	6,6	6	332 101 006	
13	21	6,6	13	332 101 013	
25	21	6,6	25	332 101 025	



Montage avec ASS Serre-câble de fixation et Serre-câble de fixation d'extrémité



ASS Serre-câble de fixation



ASS Douille de tension montée



ASS Serre-câble de fixation d'angle

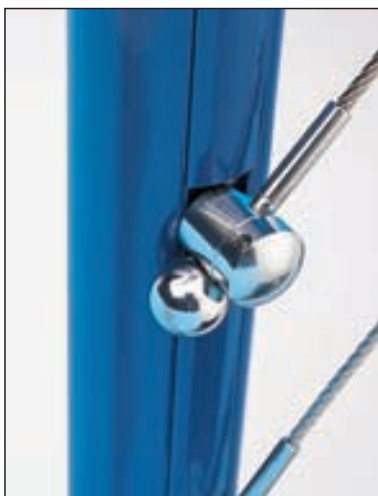

ASS Serre-câble de fixation d'extrémité



Tension du câble avec une ASS Douille de tension



Tension du câble à l'aide de ASS Manchon de tension



ASS Serre-câble à rotule

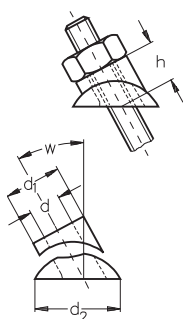

ASS Positionneur d'angle multiple
 pour poteau plat

ASS Angle positioner
 for flat posts

Désignation nominal size	pour filetage fits for thread	d mm	d ₁ mm	d ₂ mm	de from	w à to	de from mm	h à to mm	N° article stock no.	
6	M 4 - M 6	6,4	13	20	25°	45°	9,5	10,5	332 510 006	
10	M 8 - M 10	10,6	18	24	25°	45°	14,0	15,0	332 510 010	

ASS Positionneur d'angle multiple
 pour poteau rond

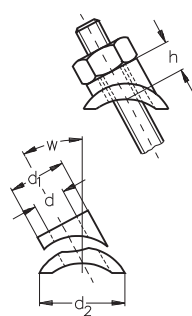
ASS Angle positioner
 for round posts

Désignation nominal size	pour filetage fits for thread	d mm	d ₁ mm	d ₂ mm	de from	w à to	de from mm	h à to mm	N° article stock no.	
6	M 4 - M 6	6,4	13	20	25°	45°	12	13	332 511 006	
10	M 8 - M 10	10,6	18	24	25°	45°	16	18	332 511 010	

Valables pour des poteaux d'un diamètre extérieur de 30 à 50 mm
 For posts with an outside diameter of 30 - 50 mm.

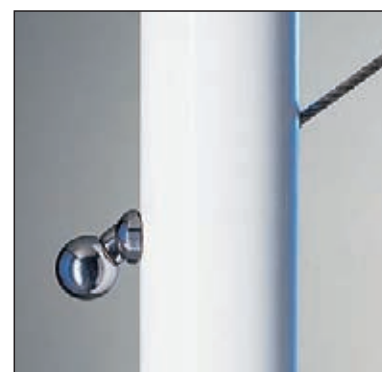
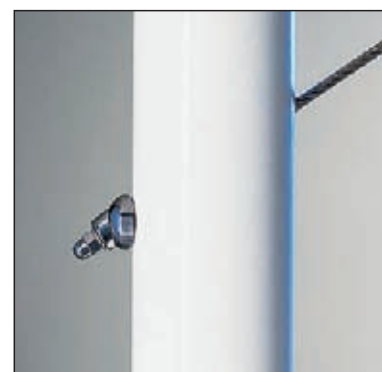
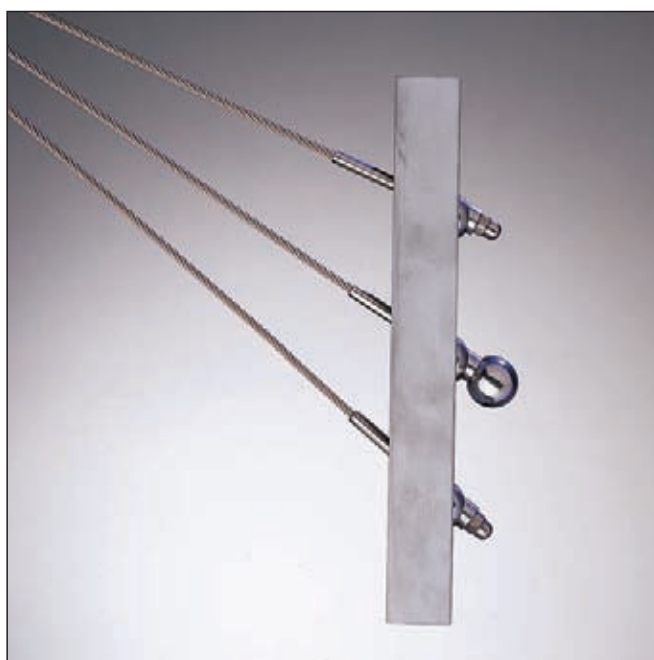

Le positionneur d'angle
 ASS permet des angles
 de 25° à 45°.

*The ASS Angle Positioner
 permits tensioning of the rope
 between 25 and 45 degrees.*

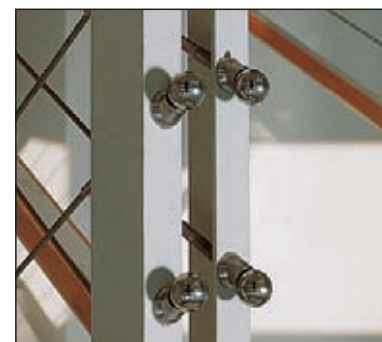

ASS Arrêt multi-angles
pour poteau **plat**

ASS Angle Stopper
for **flat** posts

DBP

Désignation nominal size	Ø câble fits for rope mm	d mm	d ₁ mm	d ₂ mm	m mm	w		N° article stock no.
						de from	à to	
4	3 + 4	6,5	15	20	4,2	25°	45°	332 520 004
6	5 + 6	10,5	20	24	6,2	25°	45°	332 520 006

Utilisable uniquement avec des ASS Super-Mini-terminaisons et pour des constructions de câbles 7 x 7 et 7 x 19.

Only applicable with ASS Threaded terminals, Super-Mini type and for rope constructions 7 x 7 and 7 x 19.

The bottom part is not slotted.

Veuillez prendre en considération que la partie inférieure n'est pas fendue.

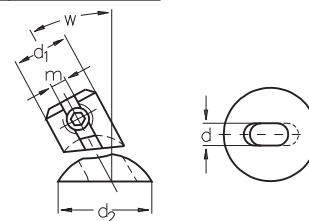

ASS Arrêt multi-angles
pour poteau **rond**

ASS Angle Stopper
for **round** posts

DBP

Désignation nominal size	Ø câble fits for rope mm	d mm	d ₁ mm	d ₂ mm	m mm	w		N° article stock no.
						de from	à to	
4	3 + 4	6,5	15	20	4,2	25°	45°	332 522 004
6	5 + 6	10,5	20	24	6,2	25°	45°	332 522 006

Utilisable uniquement avec des ASS Super-Mini-terminaisons et pour des constructions de câbles 7 x 7 et 7 x 19.

Only applicable with ASS Threaded terminals, Super-Mini type and for rope constructions 7 x 7 and 7 x 19.

For posts with an outside diameter of 30 - 50 mm.

Valables pour des poteaux d'un diamètre extérieur de 30 à 50 mm

The bottom part is not slotted.

Veuillez prendre en considération que la partie inférieure n'est pas fendue.

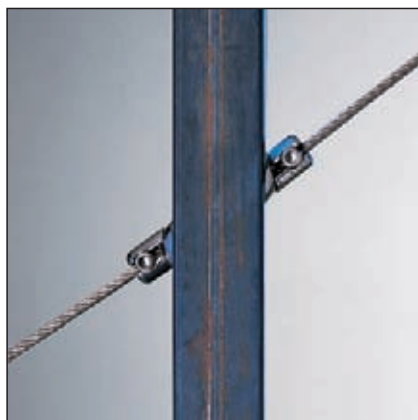
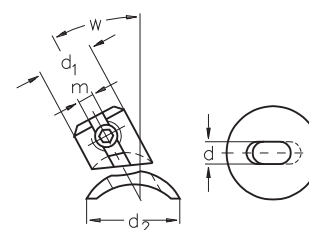

ASS Rondelle spéciale
pour poteau **rond**

ASS Special Washer
for **round** posts

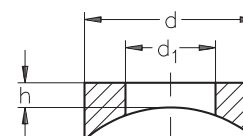

Désignation nominal size	pour filetage fits for thread up to	d mm	d ₁ mm	h mm	ø poteau diameter of the posts		N° article stock no.
					de from	à to	
6	M 6	13	6,6	3	30	50	333 010 006
10	M 10	21	11,0	3	30	50	333 010 010

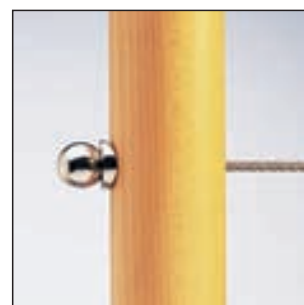
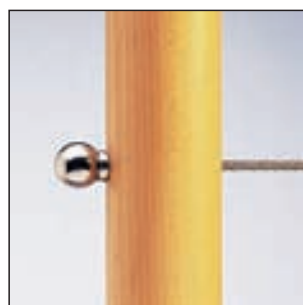
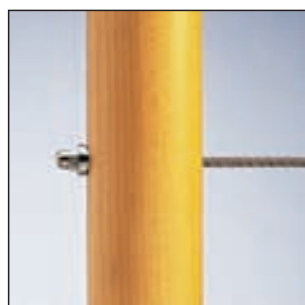

avec ASS Rondelle spéciale D. 6
with ASS Special Washer NG 6

avec ASS Rondelle spéciale D. 6
with ASS Special Washer NG 6

avec ASS Rondelle spéciale D. 10
with ASS Special Washer NG 10

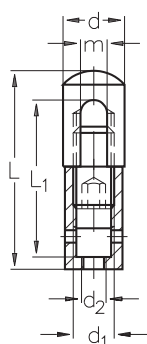

ASS Suspension monobrin avec bague

ASS Hanging unit, simple type with attaching sleeve

Désignation nominal size	*Ø câble horizontal rope-Ø horizontal mm	Ø câble vertical Terminaison cylindrique rope-Ø vertical mm	Ø câble vertical Anneau de fixation rope-Ø vertical mm	L mm	L ₁ mm	m mm	d mm	d ₁	d ₂	N° article stock no.
4	3 + 4	1,5 + 2	-	37,0	29	4,5	12	M 8	M 4	392 510 004
6	5 + 6	3 + 4	2	48,5	38	6,5	15	M 10	M 6	392 510 006

La tige filetée M 8 ou M 10 est incluse dans la livraison.

Stud M 8 or M 10 included.

Applications

Les ASS Suspensions monobrin et multibrins ont été conçues pour permettre à un câble tendu horizontalement de recevoir des suspensions verticales. Elles permettent l'accrochage de panneaux publicitaire, lampes, haut-parleurs etc. sans prise au plafond.

Avec ces mêmes pièces, il y a possibilité de stabiliser les câbles horizontaux de grandes longueurs par des fixations intermédiaires vers le haut.

Applicability

We have developed the ASS Hanging units to enable advertising boards, lights, loudspeakers etc. to be suspended from ceilings with the minimum of fixings. There are two types of ASS Hanging units the 'simple' and the 'multiple' both of which allow equipment to be hung vertically from a main horizontal rope.

In addition the ASS Hanging units may be used as a tensioning device or as an intermediate universal fitting on long horizontal rope runs.



**ASS Suspension monobrin
avec boulon à œil**

**ASS Hanging unit, simple type
with eye bolt**

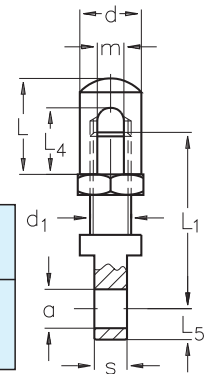

Désignation nominal size	Ø câble rope-Ø mm	L mm	L ₄ mm	m mm	d mm	L ₁ mm	d ₁	a mm	s mm	L ₅ mm	N° article stock no.
4	3 + 4	17,0	12	4,5	12	35	M 8	6,5	6	6,0	392 520 004
6	5 + 6	23,5	16	6,5	15	43	M 10	9,5	8	7,5	392 520 006
10 *	8 + 10	34,5	25	10,5	25	-	M 16	-	-	-	392 520 010

* dans cette désignation, seule la partie supérieure est disponible.

* Top half available for this size only.



ASS Suspension multibrins

ASS Hanging unit, multiple

Désignation nominal size	Ø câble rope-Ø mm	L mm	L ₁ mm	L ₂ mm	h mm	h ₁ mm	d mm	a mm	m mm	b mm	N° article stock no.
6	5 + 6	48	40	14	14	8	20	6,5	6,5	6	392 530 006



Vous trouverez de plus amples détails d'utilisations et d'applications sur notre ASS Console murale à la page 54.

Please find additional details regarding applicability and technical data for the ASS Wall bracket on page 54.

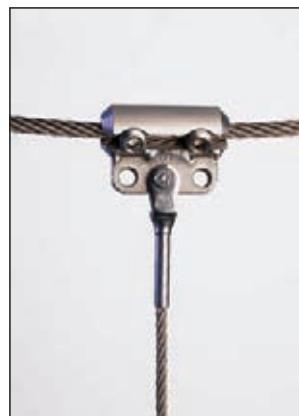
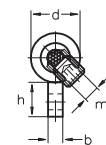
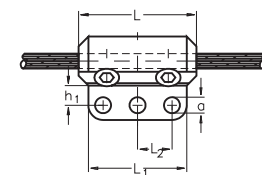
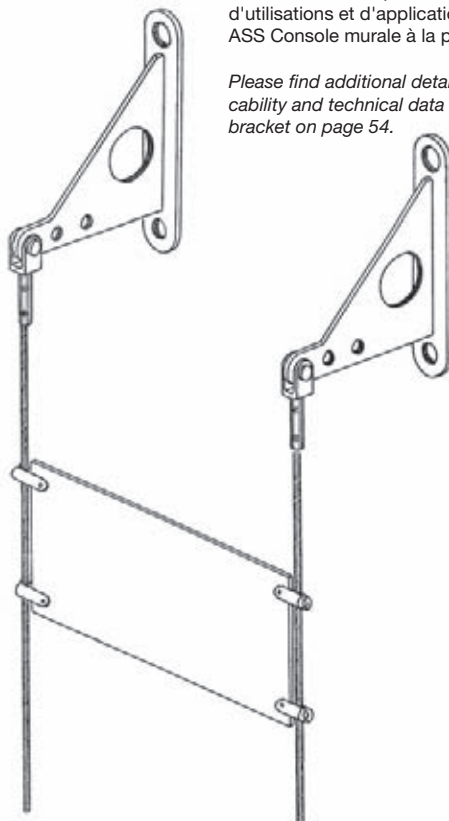

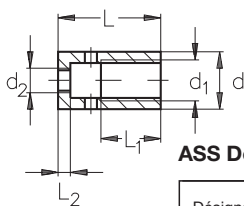

ASS Douille à visser

ASS Attaching sleeve

Désignation nominal size	∅ câble Terminaison cylindrique rope-∅ mm	∅ câble Anneau de fixation rope-∅ mm	L mm	L ₁ mm	L ₂ mm	d mm	d ₁	d ₂	N° article stock no.
M 8	1,5 + 2	-	20	12	3	12	M 8	M 4	351 010 008
M 10	3 + 4	2	25	15	3	14	M 10	M 6	351 010 010



* Les câbles de suspension sont sertis avec une ASS Terminaison cylindrique. Le M 10 peut recevoir un câble de suspension de 2 mm avec un ASS Anneau de fixation.

* The rope must have an ASS Cylindrical Terminal swaged on one end. Size M 10 can be used on a 2 mm diameter wire rope using the ASS Clamping Ring.

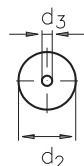

ASS Capuchon de douille

ASS Locking cap

Désignation nominal size	L mm	k mm	d ₁	d ₂ mm	d ₃ mm	N° article stock no.
M 8	9	2,5	M 8	12	2,5	351 110 008
M 10	12	3,0	M 10	14	4,5	351 110 010

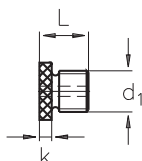

Montage avec ASS Terminaison cylindrique
Assembly with ASS Cylindrical terminal



Montage avec ASS Anneau de fixation
Assembly with ASS Clamping ring



pièces assemblées
assembled

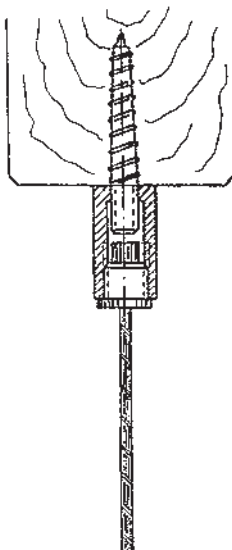

Fixation avec vis double
filets bois/métaux.
Suspension avec ASS
Terminaison cylindrique.
Fixing by wall stud
Rope with ASS Cylindrical
Terminal

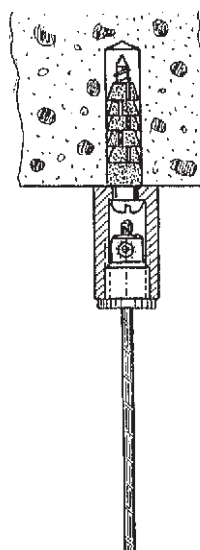

Fixation avec cheville.
Suspension avec ASS
Anneau de fixation.
Fixing by dowel
Rope with ASS Clamping
Ring

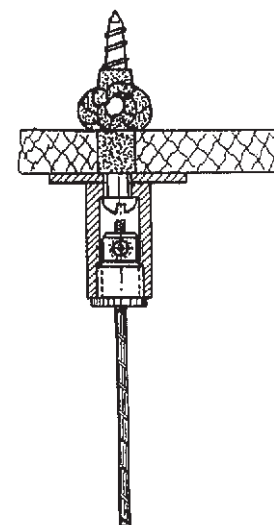

Fixation dans placoplâtre avec
ASS Cache Inox.
Fixing to plasterboard
Panel with NIRO Cover
Washer

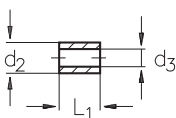

ASS Terminaison cylindrique à sertir

ASS Cylindrical terminal

Désignation nominal size	∅ câble rope-∅ mm	d ₂ mm	d ₃ mm	L ₁ mm	N° article stock no.
2	2	5,4	2,2	6	351 210 002
3	3	6,3	3,3	8	351 210 003
4	4	7,5	4,3	10	351 210 004

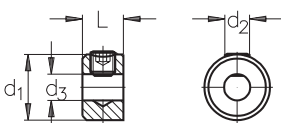

ASS Anneau de fixation à visser

ASS Clamping ring

Désignation nominal size	∅ câble rope-∅ mm	d ₁ mm	d ₂	d ₃ mm	L mm	N° article stock no.
2	2	8	M 4	2,3	6	351 310 002
3	3	10	M 4	3,3	6	351 310 003
4	4	12	M 4	4,3	8	351 310 004



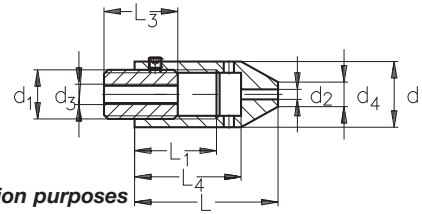

ASS Déco-Douille de tension

ASS Tensioning unit for decoration purposes

Désignation nominal size	Ø câble rope-Ø mm	L mm	L ₁ mm	L ₃ mm	L ₄ mm	d mm	d ₁	d ₂ mm	d ₃	d ₄ mm	N° article stock no.	
2	1,5 + 2	35	20	18	26	16	M 12	2,5	M 5	6	351 410 002	
4	3 + 4	40	25	23	33	20	M 16	4,5	M 6	12	351 410 004	

à utiliser avec terminaison cylindrique ou anneau de fixation

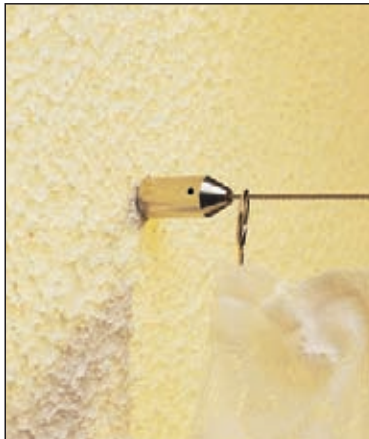

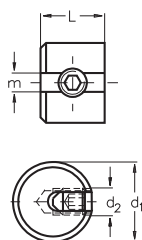

ASS Arrêt-Butoir

ASS Stopper

DBGM design protégé registered design

Désignation nominal size	Ø câble rope-Ø mm	m mm	d ₁ mm	d ₂	L mm	N° article stock no.
2	1,5 + 2	2,2	10	M 4	8	351 710 002
4	3 + 4	4,3	15	M 8	12	351 710 004
6	5 + 6	6,3	20	M 10	15	351 710 006

Utilisable que pour des constructions de câbles
7 x 7 et 7 x 19.

Only applicable for rope constructions 7 x 7 and 7 x 19.



Maniement facile



Easy Handling

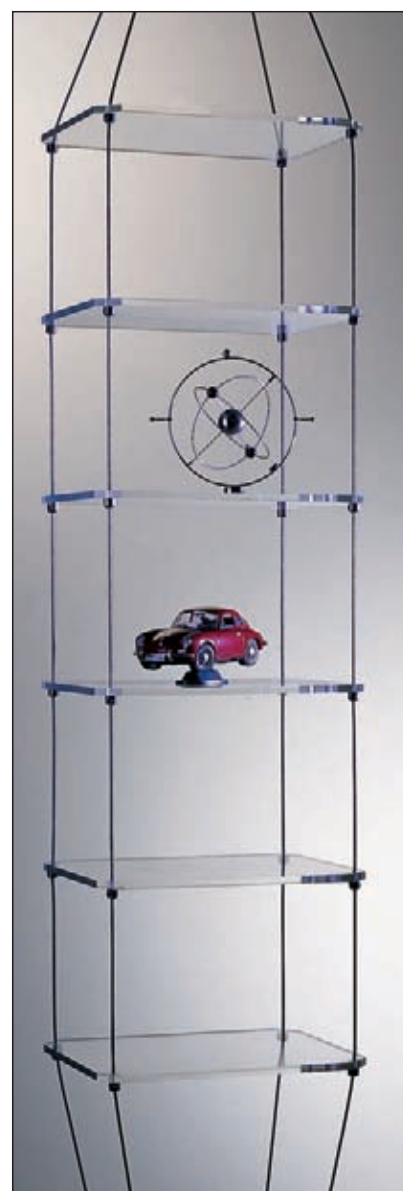

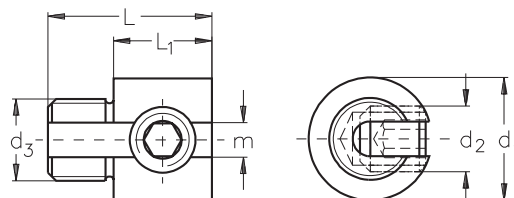

ASS Arrêt d'extrémité

ASS End stop

DBGM

Désignation nominal size	Ø câble rope-Ø mm	m mm	d ₁ mm	d ₂	d ₃	L mm	L ₁ mm	N° article stock no.	
4	3 + 4	4,3	15	M 8	M 10	20	12	333 110 004	

Utilisable que pour des constructions de câbles 7 x 7 et 7 x 19.

Only applicable for rope constructions 7 x 7 and 7 x 19.

L'arrêt d'extrémité ASS vous permet de positionner la longueur de chaque câble individuellement. L'extrémité du câble disparaît dans la boule ASS. Par conséquent, la finition est d'une part plus esthétique et d'autre part évite toute blessure par les torons du câble. L'arrêt d'extrémité est livré sans la boule ASS.

The ASS End stop enables you to cut the ropes according to your requirements. The wires at the end of the rope vanish into the screwed ASS Ball. On the one hand you have a pleasant end fitting, on the other hand the risk of injury by the sharp wires is averted. The ASS End stop is supplied without ASS Ball.

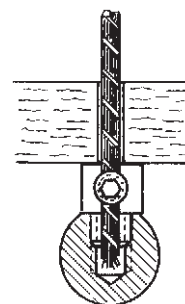

ASS Boule taudée à droite

ASS Ball with internal thread, right hand

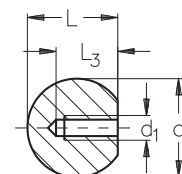

Désignation nominal size	Filetage thread d ₁	d ₂ mm	L mm	L ₃ mm	N° article stock no.	
M 4/15	M 4	15	14,0	9	333 210 400	
M 5/20	M 5	20	18,5	12	333 210 520	
M 5/24	M 5	24	22,0	15	333 210 500	
M 6/20	M 6	20	18,5	12	333 210 620	
M 6/24	M 6	24	22,0	15	333 210 600	
M 8/24	M 8	24	22,0	15	333 210 800	
M 10/24	M 10	24	22,0	15	333 211 000	

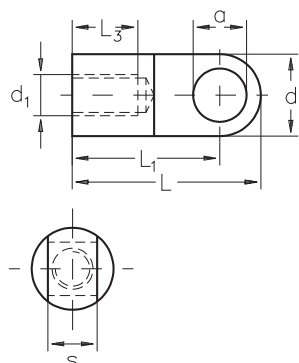

ASS Øil taraudé
taraudé à droite

ASS Wall/Ceiling Eyenut
with right hand thread

Désignation nominal size d ₁	d mm	L mm	L ₁ mm	L ₃ mm	a mm	s mm	N° article stock no.
M 4	10	23	18	5	5,5	6	351 810 004
M 5	10	23	18	5	6,5	6	351 810 005
M 6	14	30	23	6	8,5	7	351 810 006
M 8	16	33	25	8	9,5	9	351 810 008
M 10	18	34	25	12	9,5	7	351 810 010
M 12	20	36	25	15	9,5	7	351 810 012

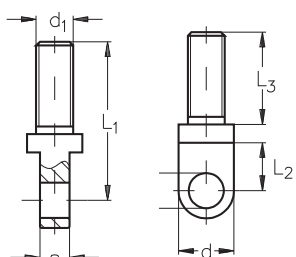

ASS Øil fileté

ASS Eye bolt

Désignation nominal size	L ₁ mm	L ₂ mm	L ₃ mm	d mm	d ₁	a mm	s mm	N° article stock no.
M 8	35	11	20	12	M 8	6,5	6	351 910 008
M 10	43	13	25	15	M 10	9,5	8	351 910 010

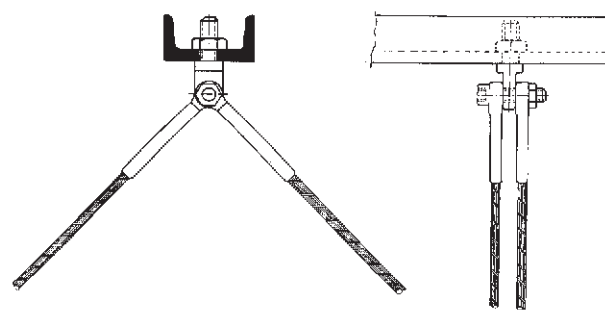
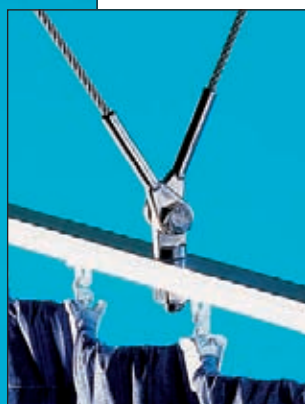



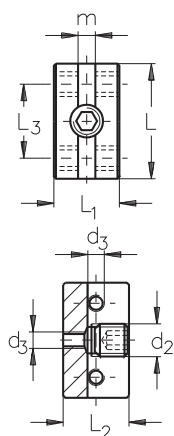

ASS Support de rayonnage
ASS Shelf Support

Désignation nominal size	Ø câble rope-Ø mm	m mm	L mm	L ₁ mm	L ₂ mm	L ₃ mm	d ₂	d ₃	N° article stock no.
4	3 + 4	4,3	25	16	16	16	M 8	M 4	352 010 004

Utilisable que pour des constructions de câbles
7 x 7 et 7 x 19.

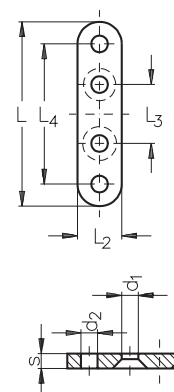
Only applicable for rope constructions 7 x 7 and 7 x 19.

ASS Attache plate pour support de rayonnage Strap for ASS Shelf Support

Désignation nominal size	L mm	L ₂ mm	L ₃ mm	L ₄ mm	d ₁ mm	d ₂ mm	s mm	N° article stock no.
4	50	12	16	38	4,5	4,5	4	352 012 004

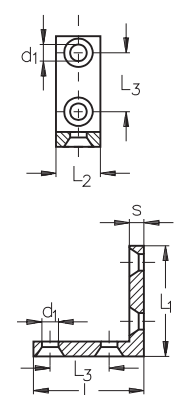
ASS Attache cornière pour support de rayonnage Angle for ASS Shelf Support

Désignation nominal size	L mm	L ₁ mm	L ₂ mm	L ₃ mm	d ₁ mm	s mm	N° article stock no.
4	30	30	12	16	4,5	4	352 013 004

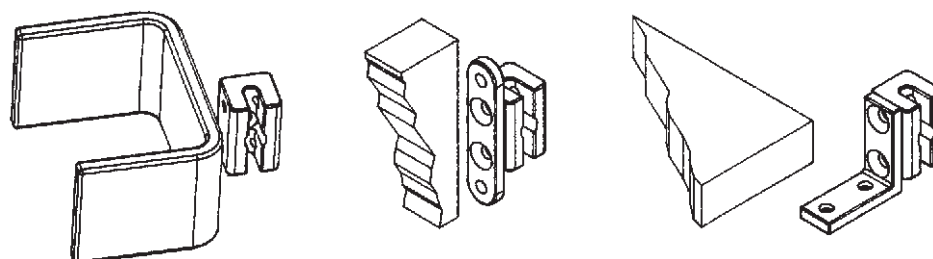

Le Support de rayonnage ASS peut, avec d'autres accessoires, être utilisé dans beaucoup de domaines.

The ASS Shelf Support can be used for numerous purposes as a single item or in connection with various accessories.

Ce Support de rayonnage ASS dispose d'une rainure pouvant recevoir un câble de 3 ou 4 mm de diamètre qui sera fixé à hauteur voulue par des vis sans tête. De chaque côté ainsi qu'à l'arrière du support se trouve des trous taraudés M 4.

The ASS Shelf Support has a slot to accept a wire rope of 3 or 4 mm diameter. By the use of a stud the ASS Shelf Support can be fixed on the rope. On both sides you will find two threaded holes M 4. In addition there is another threaded hole M 4 on the rear.

Il existe donc la possibilité de fixer des rayonnages de chaque côté du support ou d'un côté seulement, ou encore en angle droit.

One has the ability to assemble e.g. shelf-units on both sides, single or at right angles directly with the ASS Shelf Support. By using two ASS Shelf Supports the shelf-units can be assembled at any angle. For the assembly of shelves, partitions or displays we supply accessories like angles or straps.

Nos ASS Attaches plates pour support de rayonnage ainsi que nos ASS Cornières d'attache pour support de rayonnage sont utilisées pour la fixation de rayonnage, de cloisons mobiles ou de support publicitaire.

For the construction of **closed partitions**, e.g. for use at fairs and exhibitions, one might use commercial clamping profiles. These profiles can be assembled directly to the ASS Shelf Support.

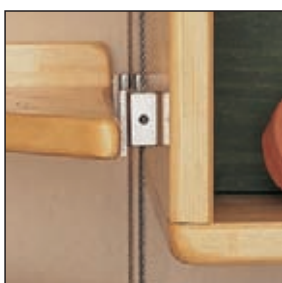
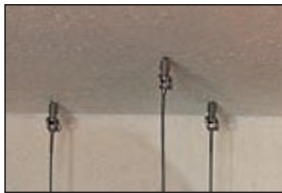

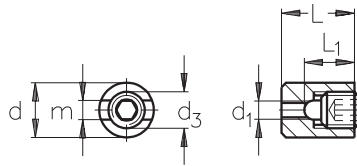

ASS Display support

ASS Display clip

Désignation nominal size	Ø câble rope-Ø mm	m mm	L mm	L ₁ mm	d mm	d ₁	d ₃	N° article stock no.
2	1,5 + 2	2,2	10	5	8	M 4	M 4	352 110 002
4	3 + 4	4,2	16	11	12	M 4	M 8	352 110 004
4/10	3 + 4	4,2	19	12	20	M 6	M 8	352 110 410

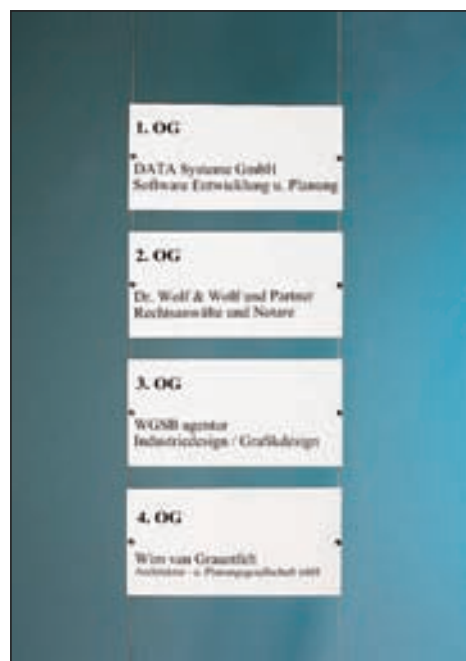
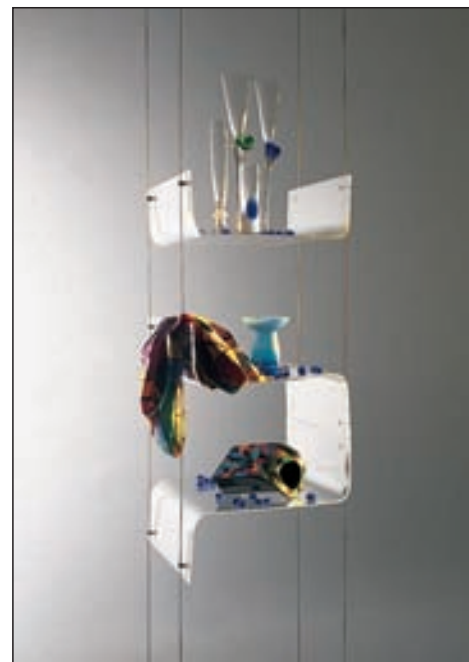
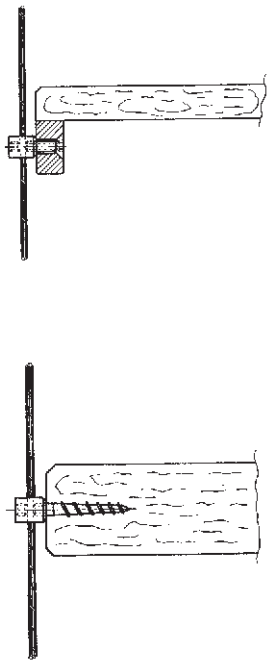

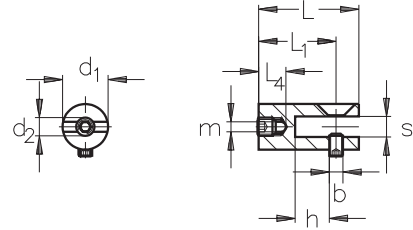

ASS Support à chape

ASS Clamping jaw

Désignation nominal size	Ø câble rope-Ø mm	L mm	L ₁ mm	L ₄ mm	d ₁ mm	d ₂ mm	m mm	h mm	b mm	s mm	N° article stock no.
2	1,5 + 2	22	17	5	10	M 4	2,2	7,5	M 3	4,5	352 210 002

En plus d'une vis M 4 x 4 pour la fixation de la chape, sont livrés une vis M 3 x 5 pour la fixation des panneaux et une vis à tête fraisée M 3 x 10 dans le cas d'un perçage dans le panneau.

The ASS Clamping Jaw is supplied with a M 4 x 4 stud for fixing the rope and a choice of M 3 x 5 stud or M 3 x 10 countersunk bolt for fixing the display material etc.

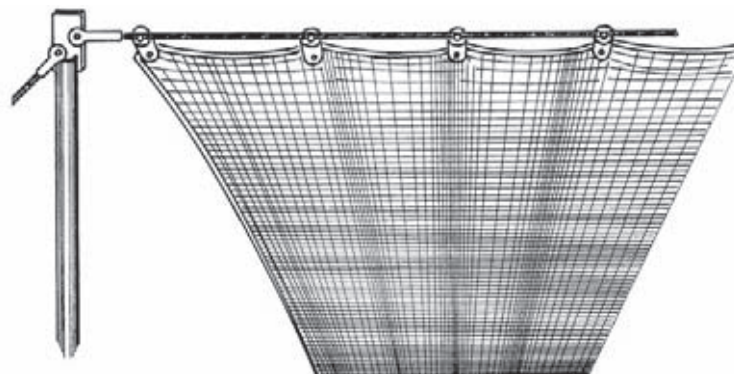

Exemple d'application d'un ASS Support à chape

Applicability ASS Clamping jaw
Tensioning of textiles as protection against sun, view or for textile ceilings.

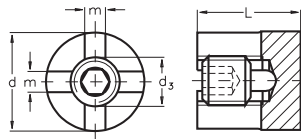

Serre-câble croisé simple INOX

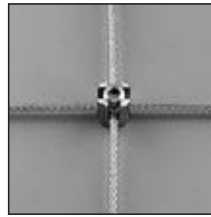

NIRO Cross-over clip, simple

Désignation nominal size	Ø câble rope-Ø mm	d mm	L mm	d ₃	m mm	N° article stock no.
4	3 + 4	20	21	M 10	4,2	341 010 004
6	5 + 6	20	25	M 12	6,2	341 010 006

pour un croisement simple des câbles sous un angle de 90°

for simple rope cross-over at right angles

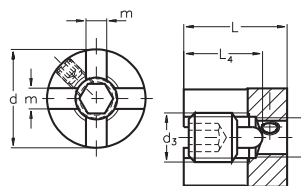

Serre-câble croisé simple INOX avec fixation murale M 8

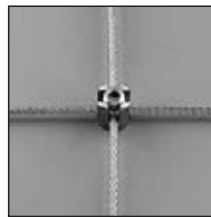

NIRO Cross-over clip, simple with connection to the wall M 8

Désignation nominal size	Ø câble rope-Ø mm	d mm	L mm	L ₄ mm	d ₁	d ₃	m mm	N° article stock no.
4	3 + 4	20	21	16	M 8	M 10	4,2	341 012 004

pour un croisement simple des câbles sous un angle de 90°, et une fixation murale au moyen d'une tige fileté M 8 (non fournie)

for rope cross-over at right angles and wall fixing with M 8 threaded rod

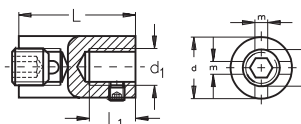

ASS Serre-câble croisé 3 D avec fixation murale M 12

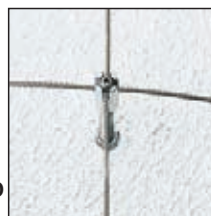

ASS Cross-over clip 3 D with connection to the wall M 12

DBGM

Désignation nominal size	Ø câble rope-Ø mm	d mm	L mm	d ₁	d ₃	L ₁ mm	m mm	N° article stock no.
4	3 + 4	20	36	M 12	M 10	10	4,2	341 014 004
6	5 + 6	20	40	M 12	M 12	10	6,2	341 014 006

pour un croisement des câbles sous un angle de 90°, et une fixation murale au moyen d'une tige fileté M 12 (non fournie). Trois différentes directions de câbles sont possibles (voir photo page 53)

for rope cross-over at right angles and wall fixing with M 12 threaded rod, three directional rope path possible (see photo page 53)

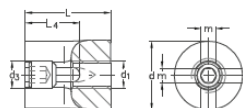

ASS Serre-câble croisé 3 D avec fixation murale M 8



ASS Cross-over clip 3 D with connection to the wall M 8

DBGM

Désignation nominal size	Ø câble rope-Ø mm	d mm	L mm	d ₁	d ₃	L ₄ mm	m mm	N° article stock no.
4	3 + 4	20	25	M 8	M 10	16	4,2	341 114 004



ASS Serre-câble croisé multi-angles

ASS Cross-over clip

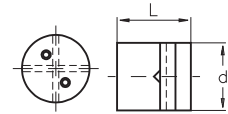

DBGM
Design
Protégé
registered
design

Désignation nominal size	Marquage marking	Ø câble rope-Ø mm	d mm	L mm	N° article stock no.
4	v	3 + 4	22	24	341 016 004
6	∨	5 + 6	22	26	341 016 006

pour un croisement des câbles sous n'importe quel angle **for rope cross-over at any angle**

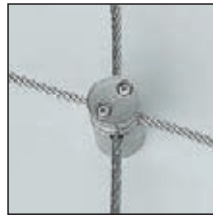

ASS Serre-câble croisé multi-angles

avec fixation murale M 12

ASS Cross-over clip

with connection to the wall M 12

DBGM
design protégé
registered design

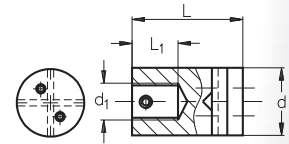

Désignation nominal size	Marquage marking	Ø câble rope-Ø mm	d ₁	d mm	L ₁ mm	L mm	N° article stock no.
4	v	3 + 4	M 12	22	15	36	341 018 004
6	∨	5 + 6	M 12	22	15	38	341 018 006

pour un croisement des câbles sous n'importe quel angle, et une fixation murale au moyen d'une tige filetée M 12 (non fournie) (voir photo page 53) **for rope cross-over at any angle and wall fixing with M 12 threaded rod (see photo page 53)**



ASS Serre-câble croisé multi-angles

avec fixation murale M 12 et une déviation latérale à œil

ASS Cross-over clip

with connection to the wall M 12 and eye connector

DBGM
design protégé
registered design

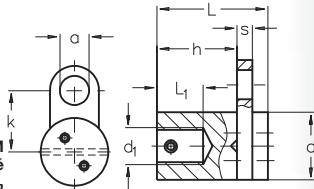

Désignation nominal size	Ø câble rope-Ø mm	d ₁	d mm	L ₁ mm	L mm	s mm	k mm	h mm	a mm	N° article stock no.
6	3 - 6	M 12	22	15	36	6	20	24	9,5	341 020 006

pour un positionnement de câble horizontal et vertical, muni d'un œil latéral offrant une connexion supplémentaire et d'une fixation murale au moyen d'une tige filetée M 12 (non fournie) (voir photo page 53) **for ropes in the horizontal and vertical planes with one eye connector for additional connections, fixing to the wall with M 12 rod (see photo page 53)**



ASS Serre-câble croisé multi-angles

avec fixation murale M 12 et deux déviations latérales à œil

ASS Cross-over clip

with connection to the wall M 12 and two eye connectors

DBGM
design protégé
registered design

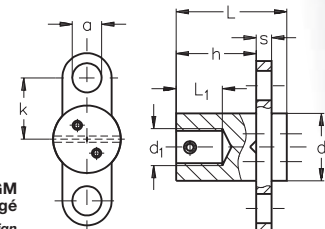

Désignation nominal size	Ø câble rope-Ø mm	d ₁	d mm	L ₁ mm	L mm	s mm	k mm	h mm	a mm	N° article stock no.
6	3 - 6	M 12	22	15	36	6	20	24	9,5	341 021 006

pour un positionnement de câble horizontal et vertical, muni de deux œils latéraux offrant deux connexions supplémentaires et d'une fixation murale au moyen d'une tige filetée M 12 (non fournie) **for ropes in the horizontal and vertical planes with two eye connectors for additional connections, fixing to the wall with M 12 rod**



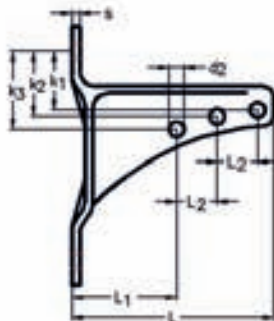

ASS Console Murale

Fixation par terminaison à chape

ASS Wall Bracket

for connection with jaws

T mm	T1 mm	T2 mm	d1 mm	d2 mm	s mm	b mm	n mm	L mm	L1 mm	L2 mm	k1 mm	k2 mm	k3 mm	N° article stock no.
160	130	15	9	9,5	5	30	4	125	65	25	36,5	40,5	48,5	341 520 005

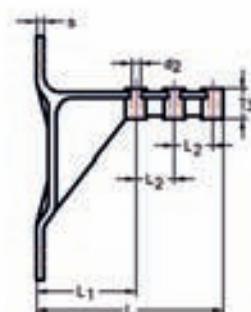
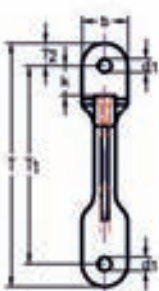

ASS Console Murale

Fixation par terminaison filetée

ASS Wall Bracket

for threaded terminal

T mm	T1 mm	T2 mm	T3 mm	k mm	d1 mm	d2 mm	s mm	b mm	L mm	L1 mm	L2 mm	N° article stock no.
160	130	15	20	20	9	6,2	5	30	122	65	25	341 520 001

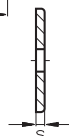
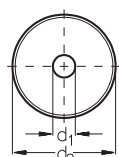

ASS Rosace

pour console murale

ASS Rose

for the wall bracket

Désignation nominal size	Présentation type	d1 mm	d2 mm	s mm	N° article stock no.
60 x 13	biseautée turned with facet	13	60	5	341 610 001
58 x 14	estampée punched	14	58	5	341 710 014

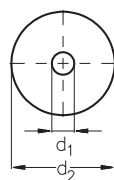

Cache Inox

pour console murale, estampé

NIRO Cover Washer

punched

Désignation nominal size	d2 mm	d1 mm	s mm	N° article stock no.
30	30	5,5	1,5	341 710 030
40	40	6,4	1,5	341 710 040
45	45	8,5	2,0	341 710 045
50	50	11,0	2,0	341 710 050
60	60	13,0	3,0	341 710 060
70	70	13,0	3,0	341 710 070

ASS Console murale type Y
ASS Wall bracket, Y-type

Désignation nominal size	d ₁ mm	d ₂ mm	d ₅ mm	T ₁ mm	L ₁ mm	L ₂ mm	a mm	b	s mm	N° article stock no.
70 x 13	13	70	30	26	22	11	4,0	M 6	8,5	341 810 070

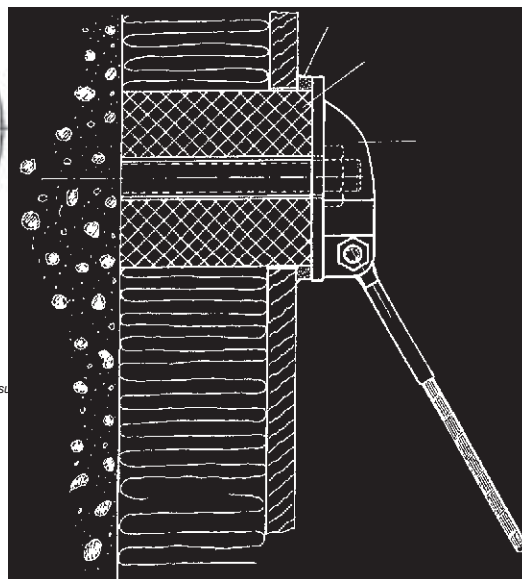
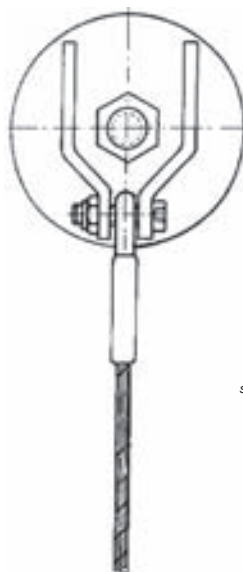
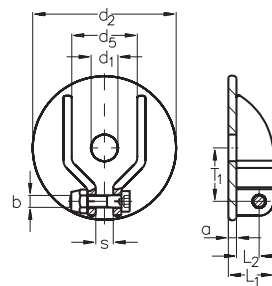

ASS Console murale, petit modèle
ASS Wall bracket, small type

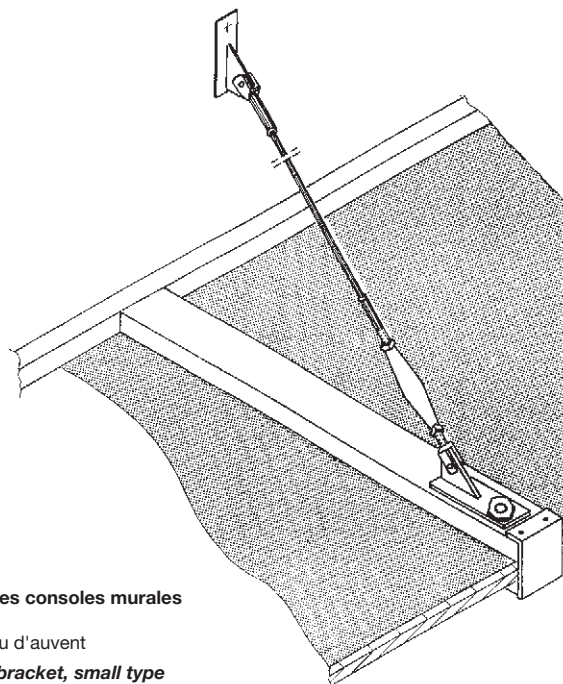
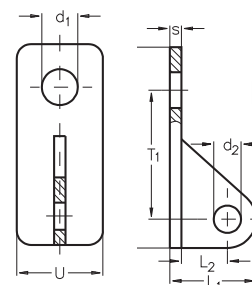
Désignation nominal size	U mm	T mm	T ₁ mm	s mm	L ₁ mm	L ₂ mm	d ₁ mm	d ₂ mm	N° article stock no.
10	10	28	16,5	2	14	7	6,5	5,5	341 910 010
20	20	48	30	3	20	9	8,5	6,5	341 910 020
30	30	70	45	4	30	16	12,5	9,5	341 910 030

Exemple d'utilisation des consoles murales dés. 20 ou 30

Fixation de rayonnage ou d'auvent

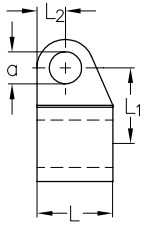
Applicability ASS Wall bracket, small type
 Hanging of shelves or canopies



ASS Douille à œil

ASS Sleeve with eye connector

Désignation nominal size	L mm	L ₁ mm	L ₂ mm	d mm	d ₁ mm	a mm	s mm	N° article stock no.
6	15	12	5	12	6,5	5,5	3	342 010 006
8	18	15	7,5	15	8,5	8,5	3	342 010 008
10	20	20	7,5	20	10,5	8,5	5	342 010 010
12	20	20	7,5	20	12,5	8,5	5	342 010 012

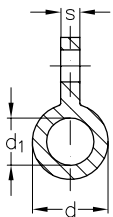

**Application
Applicability**

Renfort horizontal pour treillage avec un grand écartement du mur et des plantes lourdes

*Horizontal running plant support with large distance to the wall and heavy plant
Forces of the vertical plant weight imparted*

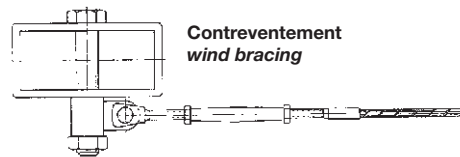
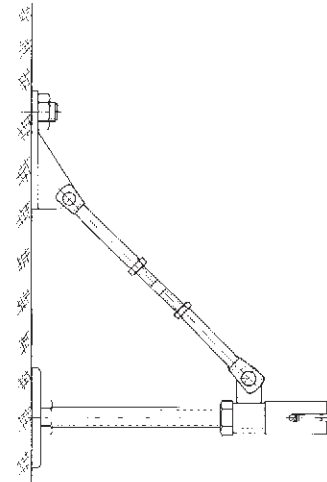

ASS Élément de protection et de déviation

ASS Piggyback clip

Désignation nominal size	Ø câble principal Ø main rope mm	Ø câble secondaire Ø cross rope mm	L mm	h mm	b mm	d mm	m mm	N° article stock no.
6	5 + 6	3 + 4	48	10	12	20	6,5	393 010 006



Possibilité d'application

Cette pièce sert à la déviation de câble secondaire par rapport à un câble principal, sans que ce dernier ne soit blessé par des angles aigus.

Applicability

The ASS Piggyback Clip is meant for the stabilization of the rope. The rope will be tensioned at the point of intersection without sharp-edged bend in three-dimensional direction.



Le support intermédiaire se compose de :

- Tige filetée M 12
- ASS Rosace ou Cache Inox
- Ecrou à six pans Inox
- ASS Serre-câble croisé

The distance unit consists of:

- NIRO Threaded rod M 12
- ASS Rose or NIRO Cover Washer
- NIRO Hexagon nut
- ASS Cross-over clip

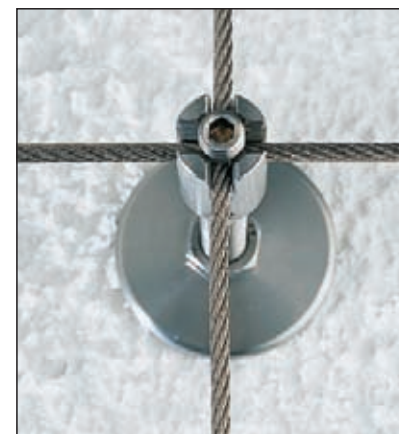



Conception et réalisation pour habiller un mur de verdure.

Vous envisagez de faire pousser des plantes sur une façade ?

Afin de garantir un bon résultat, vous devez impérativement suivre les règles suivantes :

Sélection des plantes

- L'exposition de la façade détermine le choix des plantes.
- La surface disponible (hauteur et largeur du mur) doit correspondre à la taille de la plante en pleine maturité.
- En outre la structure de la façade est décisive, si elle présente des joints ouverts ou des ouvertures de ventilation, il est déconseillé d'y faire pousser des plantes dont les pousses fuient la lumière car celles-ci y pénétreraient.

Influence du vent

Lorsque vous avez sélectionné vos plantes, il faut prendre en considération le poids de celles-ci au stade de la maturité afin de déterminer la charge du vent sur l'ensemble de la construction.

Construction et treillage

Les plantes ayant développé des techniques de pousse différentes (volubiles, sarmenteuses, à pousses, à crampons), les supports doivent toujours correspondre à ces techniques.

Le type de plante, son poids, la force du vent détermineront le nombre de câbles ainsi que le nombre de fixations intermédiaires.

Si le mur ne peut supporter les charges déterminées ci-dessus, il faudra augmenter le nombre de câbles et de points de fixation.

The planning and assembly of facade foliage

Are you planning a facade with foliage?

To ensure a satisfactory result the following criteria must be considered.

Choice of plants

- *The aspect of the wall determines the choice of plants.*
- *The surface area available, allowing for final plant size.*
- *The facade construction, plants with vigorous tendrils will not be suitable if the wall has open joints.*

Wind Effect

The expected final weight of the selected plant must be considered when calculating the wind effect on the complete construction.

Construction and plant support

Different type plants have evolved different climbing techniques, i.e. climbers, ramblers etc.

Plant type, wind force, weight and fixing of the anchoring system determine the number of ropes and intermediate fittings to be employed. If the wall or the facade cannot bear the calculated forces for structural reasons then more ropes and/or intermediate fittings must be used.



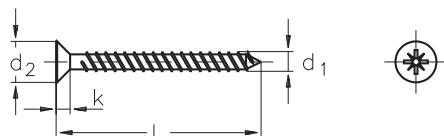

Vis cruciforme INOX
pour bois aggloméré

NIRO Cross recessed chipboard screw

Désignation nominal size	d ₁ mm	d ₂ mm	L mm	k mm	N° article stock no.
3 x 25	3	6	25	1,9	303 010 325
4 x 40	4	8	40	2,5	303 010 440
5 x 50	5	10	50	3,0	303 010 550
6 x 60	6	12	60	3,6	303 010 660

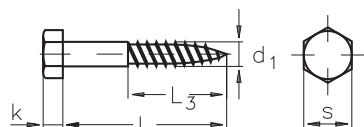

Vis six pans à bois INOX, DIN 571

NIRO Hexagon wood screw acc. to DIN 571

Désignation nominal size	d ₁ mm	L mm	L ₃ mm	s mm	k mm	N° article stock no.
5 x 30	5	30	18	8	3,5	303 011 530
6 x 40	6	40	24	10	4,0	303 011 640
6 x 70	6	70	42	10	4,0	303 011 670
8 x 80	8	80	48	13	5,5	303 011 880

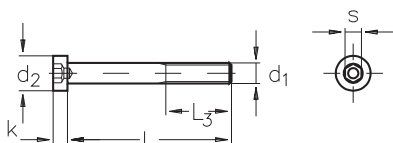

Vis Allen tête basse INOX, DIN 6912
filetage à droite

**NIRO Cylindrical screw with hexagon
socket head acc. to DIN 6912, right hand thread**

Désignation nominal size	d ₁	d ₂ mm	L mm	L ₃ mm	k mm	s mm	N° article stock no.
M 4 x 12	M 4	7,0	12	9,9	2,8	3	303 012 412
M 5 x 10	M 5	8,5	10	7,6	3,5	4	303 012 510
M 5 x 16	M 5	8,5	16	13,6	3,5	4	303 012 516
M 5 x 20	M 5	8,5	20	17,6	3,5	4	303 012 520
M 5 x 30	M 5	8,5	30	16,0	3,5	4	303 012 530
M 5 x 40	M 5	8,5	40	16,0	3,5	4	303 012 540
M 6 x 10	M 6	10	10	7,0	4,0	5	303 012 610
M 6 x 16	M 6	10	16	13,0	4,0	5	303 012 616
M 6 x 20	M 6	10	20	17,0	4,0	5	303 012 620
M 6 x 30	M 6	10	30	18,0	4,0	5	303 012 630
M 6 x 40	M 6	10	40	18,0	4,0	5	303 012 640
M 6 x 60	M 6	10,0	60	18,0	4,0	5	303 012 660
M 8 x 16	M 8	13,0	16	12,0	5,0	6	303 012 816
M 8 x 20	M 8	13,0	20	16,0	5,0	6	303 012 820
M 8 x 30	M 8	13,0	30	26,0	5,0	6	303 012 830
M 8 x 40	M 8	13,0	40	22,0	5,0	6	303 012 840
M 8 x 60	M 8	13,0	60	22,0	5,0	6	303 012 860

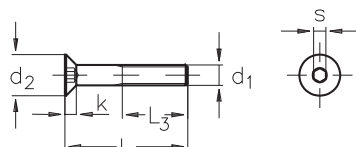

**Vis Allen tête fraisée INOX,
DIN 7991**
filetage à droite

**NIRO Countersunk bolt
with hexagon socket head acc. to DIN 7991**
right hand thread

Désignation nominal size	d ₁	d ₂ mm	L mm	L ₃ mm	k mm	s mm	N° article stock no.
M 4 x 10	M 4	8	10	-	2,3	2,5	303 013 410
M 4 x 25	M 4	8	25	14	2,3	2,5	303 013 425
M 5 x 30	M 5	10	30	16	2,8	3,0	303 013 530
M 6 x 50	M 6	12	50	18	3,3	4,0	303 013 650

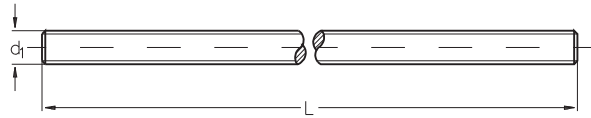

Tige filetée INOX
filetage à droite

NIRO Threaded rod
right hand thread

Désignation nominal size	d ₁	L mm	N° article stock no.
M 4	M 4	500	302 040 500
M 5	M 5	60	302 050 060
M 5	M 5	100	302 050 100
M 5	M 5	500	302 050 500
M 5	M 5	1000	302 051 000
M 6	M 6	70	302 060 070
M 6	M 6	110	302 060 110
M 6	M 6	500	302 060 500
M 6	M 6	1000	302 061 000
M 8	M 8	80	302 080 080
M 8	M 8	120	302 080 120
M 8	M 8	500	302 080 500
M 8	M 8	1000	302 081 000
M 10	M 10	100	302 100 100
M 10	M 10	500	302 100 500
M 10	M 10	1000	302 101 000
M 12	M 12	500	302 120 500
M 12	M 12	1000	302 121 000

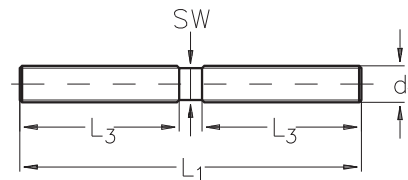

Goujon INOX
une extrémité filetée à droite, l'autre à gauche

NIRO Stud
right/left hand thread

Désignation nominal size d ₁	L ₁ mm	L ₃ mm	SW mm	N° article stock no.
M 5	55	25	4	302 510 005
M 6	65	30	5	302 510 006
M 8	75	35	7	302 510 008
M 10	85	40	9	302 510 010

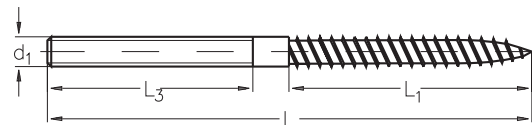

Vis à double filets INOX bois/métaux
Filetage bois toujours à droite
filetage métrique à droite ou à gauche

NIRO Wall Stud
with right and left hand thread

Désignation nominal size d ₁	L mm	L ₁ mm	L ₃ mm	Filetage à droite right hand thread N° article stock no.	Filetage à gauche left hand thread N° article stock no.
M 4 x 70	70	40	28	303 014 004	-
M 5 x 80	80	43	32	303 014 005	303 015 005
M 6 x 50	50	28	18	303 014 106	-
M 6 x 70	70	35	25	303 014 670	-
M 6 x 90	90	50	35	303 014 006	303 015 006
M 8 x 60	60	32	22	303 014 108	-
M 8 x 90	90	50	35	303 014 890	-
M 8 x 130	130	65	55	303 014 008	303 015 008
M 10 x 70	70	38	28	303 014 110	-
M 10 x 150	150	75	55	303 014 010	303 015 010
M 12 x 150	150	60	50	303 014 012	-

Sans précision, l'article ci-dessus sera livré fileté à droite.
The Wall studs are delivered with right hand thread unless specified otherwise.



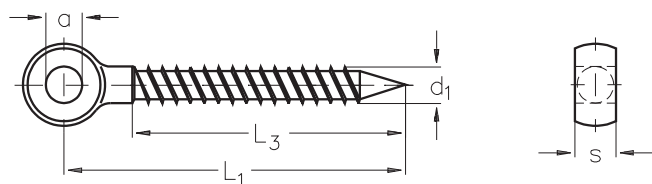

Vis à œil INOX, DIN 444
filetage bois à droite

NIRO Eye Bolt acc. to DIN 444
with wood thread, right hand

Désignation nominal size d ₁	L ₁ mm	L ₃ mm	a mm	s mm	N° article stock no.
5	60	50	5	6	303 016 005
6	60	50	6	7	303 016 006
8	75	60	8	9	303 016 008
10	85	70	10	12	303 016 010

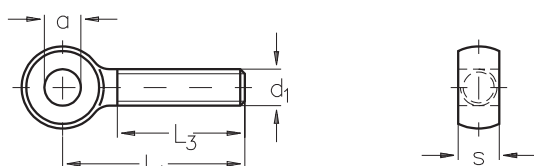

Vis à œil INOX, DIN 444
filetage métrique à droite

NIRO Eye Bolt acc. to DIN 444
with metric thread, right hand

Désignation nominal size d ₁	L ₁ mm	L ₃ mm	a mm	s mm	N° article stock no.
M 5	30	21	5	6	303 017 005
M 6	35	18	6	7	303 017 006
M 8	40	27	8	9	303 017 008
M 10	50	31	10	12	303 017 010



Piton à œil fileté INOX
modèle long, filetage à droite

NIRO Shank Collared Eye Bolt
long type, right hand thread

Désignation nominal size d ₁	L mm	L ₃ mm	a mm	s mm	N° article stock no.
M 6	60	54	16	5	303 018 006
M 8	80	70	20	6	303 018 008
M 10	100	88	24	8	303 018 010
M 12	100	88	30	10	303 018 012

Rondelle INOX, DIN 125
forme A

NIRO Washer DIN 125
Form A

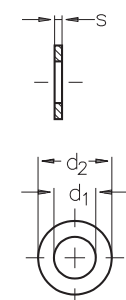

Désignation nominal size	d ₁ mm	d ₂ mm	s mm	N° article stock no.
4,3	4,3	9	0,8	303 110 004
5,3	5,3	10	1,0	303 110 005
6,4	6,4	12,5	1,6	303 110 006
8,4	8,4	17	1,6	303 110 008
10,5	10,5	21	2,0	303 110 010
13	13	24	2,5	303 110 013
17	17	30	3,0	303 110 017



Ecrou borgne INOX, DIN 1587
filetage à droite

NIRO Capped nut DIN 1587
right hand thread

Désignation nominal size	d	L mm	e mm	s mm	N° article stock no.
M 4	M 4	5	7,7	7	303 120 004
M 5	M 5	7,5	8,8	8	303 120 005
M 6	M 6	8	11,1	10	303 120 006
M 8	M 8	11	14,4	13	303 120 008
M 10	M 10	13	18,9	17	303 120 010
M 12	M 12	16	21,1	19	303 120 012
M 16	M 16	21	26,8	24	303 120 016

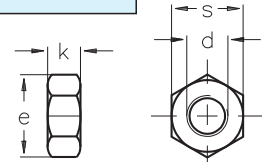
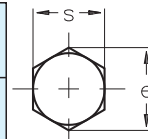
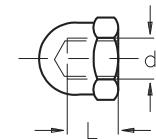

Ecrou à six pans INOX, DIN 934
filetage à droite ou à gauche

NIRO Hexagon nut DIN 934
right and left hand thread

Désignation nominal size	d	e mm	s mm	k mm	Filetage à droite right hand thread N° article stock no.	Filetage à gauche left hand thread N° article stock no.
M 3	M 3	6,0	5,5	2,4	303 510 003	303 511 003
M 4	M 4	7,7	7	3,2	303 510 004	-
M 5	M 5	8,8	8	4	303 510 005	303 511 005
M 6	M 6	11,1	10	5	303 510 006	303 511 006
M 8	M 8	14,4	13	6,5	303 510 008	303 511 008
M 10	M 10	18,9	17	8	303 510 010	303 511 010
M 12	M 12	21,1	19	10	303 510 012	303 511 012
M 14	M 14				303 510 014	-
M 16	M 16	26,8	24	13	303 510 016	303 511 016
M 20	M 20	33,6	30	19	303 510 020	303 511 020

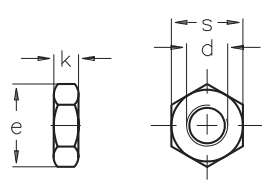

Ecrou bas à six pans INOX, DIN 439
filetage à droite ou à gauche

NIRO Hexagon lock nut DIN 439
right and left hand thread

Désignation nominal size	d	e mm	s mm	k mm	Filetage à droite right hand thread N° article stock no.	Filetage à gauche left hand thread N° article stock no.
M 4	M 4	7,7	7	2,1	303 512 004	303 513 004
M 5	M 5	8,8	8	2,7	303 512 005	303 513 005
M 6	M 6	11,1	10	3,2	303 512 006	303 513 006
M 8	M 8	14,4	13	4,0	303 512 008	303 513 008
M 10	M 10	18,9	17	5,0	303 512 010	303 513 010
M 12	M 12	21,1	19	6,0	303 512 012	303 513 012
M 16	M 16	26,8	24	8,0	303 512 016	303 513 016

**Ecrou anti-desserrage INOX
DIN 985**
filetage à droite

**NIRO Self-locking hexagon nut
acc. to DIN 985**
right hand thread

Désignation nominal size	d	e mm	s mm	k mm	N° article stock no.
M 4	M 4	7,7	7	5	303 514 004
M 5	M 5	8,8	8	5	303 514 005
M 6	M 6	11,1	10	6	303 514 006
M 8	M 8	14,4	13	8	303 514 008
M 10	M 10	18,9	17	10	303 514 010
M 12	M 12	21,1	19	12	303 514 012

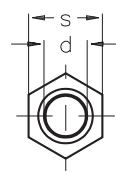
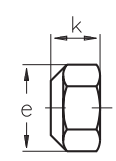

Sans précision, les articles ci-dessus seront livrés filetés à droite.
All items are delivered with right hand thread unless specified otherwise.

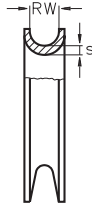
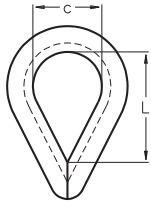
Cosse INOX
NIRO Thimble

Gorge RW groove RW mm	c mm	L mm	s mm	N° article stock no.
3	10	18	1,0	308 900 003
4	11	20	1,0	308 900 004
5	13	21	1,0	308 900 005
6	16	28	1,2	308 900 006
7	17	31	1,2	308 900 007
8	19	33	1,4	308 900 008
10	24	38	1,9	308 900 010
12	27	42	2,0	308 900 012
14	33	51	2,2	308 900 014
16	37	60	2,5	308 900 016
18	41	67	4,0	308 900 018
20	46	73	4,0	308 900 020
22	49	78	5,0	308 900 022
24	55	93	5,0	308 900 024
28	67	105	6,0	308 900 028

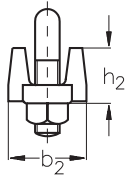
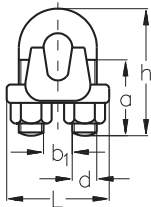
Serre-câble à étrier INOX
NIRO Wire rope clip
série lourde
heavy pattern

Désignation = Ø câble maxi nominal size = max. rope-Ø mm	a mm	b ₁ mm	b ₂ mm	d	h ₁ mm	h ₂ mm	L mm	N° article stock no.
2	10	4	15	M 3	17	10	14	309 000 002
3	12	5	15	M 3	21	12	16	309 000 003
4	13	6	18	M 4	23	13	18	309 000 004
5	14	7	21	M 5	27	16	20	309 000 005
6	18	8	23	M 6	32	18	27	309 000 006
8	22	10	28	M 8	41	20	34	309 000 008
10	27	12	36	M 10	51	23	44	309 000 010
12	33	14	38	M 12	62	27	50	309 000 012
14	38	15	44	M 12	69	31	52	309 000 014
16	45	18	47	M 14	79	35	59	309 000 016
18	47	20	52	M 14	81	38	61	309 000 018
22	60	25	61	M 18	98	45	72	309 000 022
25	60	28	62	M 16	106	53	77	309 000 025

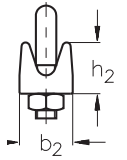
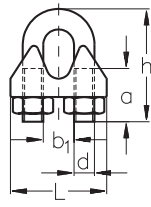
Serre-câble à étrier INOX
NIRO Wire rope clip
série légère
light pattern

Désignation = Ø câble maxi nominal size = max. rope-Ø mm	a mm	b ₁ mm	b ₂ mm	d	h ₁ mm	h ₂ mm	L mm	N° article stock no.
2	10	4	10	M 3	18	10	18	309 010 002
3	12	5	10	M 3	22	11	19	309 010 003
4	12	6	11	M 4	23	13	22	309 010 004
5	15	7	13	M 5	28	15	26	309 010 005
6	18	8	16	M 6	33	17	29	309 010 006
8	18	11	18	M 6	36	20	32	309 010 008
10	22	13	20	M 8	45	23	38	309 010 010
13	26	15	26	M 10	55	25	47	309 010 013
16	32	18	27	M 10	65	32	53	309 010 016
19	36	22	29	M 12	75	38	62	309 010 019
22	38	24	31	M 12	83	43	63	309 010 022
25	45	27	31	M 14	94	43	68	309 010 025

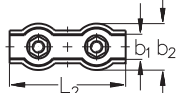
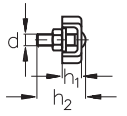
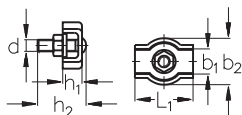
Serre-câble plat INOX à 1 boulon
Serre-câble plat INOX à 2 boulons
NIRO Simplex clip single box-type, with 1 screw
NIRO Duplex clip double box-type, with 2 screws

Désignation = Ø câble nominal size = rope-Ø mm	b ₁ mm	b ₂ mm	d	h ₁ mm	h ₂ mm	L ₁ mm	L ₂ mm	N° article stock no. 1 boulon Simplex	N° article stock no. 2 boulons Duplex
2	4	12	M 4	5	14	15	30	309 100 002	309 101 002
3	6	14	M 4	7	14	17	35	309 100 003	309 101 003
4	8	18	M 5	7	18	20	40	309 100 004	309 101 004
5	10	20	M 5	8	18	25	50	309 100 005	309 101 005
6	12	24	M 6	9	23	30	60	309 100 006	309 101 006
8	17	30	M 8	13	25	37	75	309 100 008	309 101 008
10	21	35	M 10	16	32	-	95	-	309 101 010

Tendeur INOX à cage ouverte à deux œils

NIRO Turnbuckle open type with eye and eye

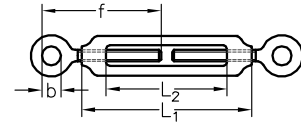

Désignation = Ø filetage nominal size = thread-Ø	Rupture * breaking load * kg	b mm	f mm	L ₁ mm	L ₂ mm	N° article stock no.
M 5	400	7	50	70	55	308 500 005
M 6	800	10	70	90	65	308 500 006
M 8	1200	12	95	120	95	308 500 008
M 10	1900	15	110	150	120	308 500 010
M 12	3400	19	140	200	165	308 500 012
M 16	5000	20	180	250	215	308 500 016
M 20	8000	28	190	305	250	308 500 020

* Attention : ne pas confondre charge de rupture et charge utile.
* Please note that the above figures are breaking load limits and not working load limits.

Tendeur INOX à cage ouverte à deux chapes contre-écrous montés

NIRO Turnbuckle open type with clevis endings

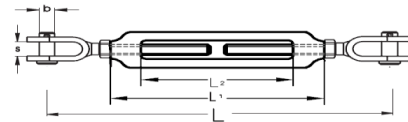

Désignation = Ø filetage nominal size = thread-Ø	Rupture * breaking load * kg	s mm	b mm	L mm	L ₁ mm	L ₂ mm	N° article stock no.
M 12	3 400	15	12	295	200	170	308 503 012
M 16	5 000	17	16	328	200	162	308 503 016

Tendeur INOX à cage ouverte à œil et crochet

NIRO Turnbuckle open type with hook and eye

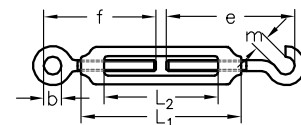

Désignation = Ø filetage nominal size = thread-Ø	Rupture * breaking load * kg	b mm	e mm	f mm	L ₁ mm	L ₂ mm	m mm	N° article stock no.
M 5	100	7	55	50	70	55	6	308 501 005
M 6	200	10	70	70	90	65	8	308 501 006
M 8	350	12	95	95	120	95	9	308 501 008
M 10	500	15	110	110	150	120	12	308 501 010
M 12	1000	19	140	140	200	165	13	308 501 012
M 16	1500	20	180	180	250	215	17	308 501 016
M 20 ³ / ₄ "	2000	28	195	190	305	250	20	308 501 020

* Attention : ne pas confondre charge de rupture et charge utile.
* Please note that the above figures are breaking load limits and not working load limits.

Tendeur INOX à cage ouverte à deux crochets

NIRO Turnbuckle open type with hook and hook

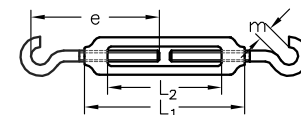

Désignation = Ø filetage nominal size = thread-Ø	Rupture * breaking load * kg	e mm	L ₁ mm	L ₂ mm	m mm	N° article stock no.
M 5	100	55	70	55	6	308 502 005
M 6	200	70	90	65	8	308 502 006
M 8	350	95	120	95	9	308 502 008
M 10	500	110	150	120	12	308 502 010
M 12	1000	140	200	165	13	308 502 012
M 16	1500	180	250	215	17	308 502 016
M 20 ³ / ₄ "	2000	195	305	250	20	308 502 020

* Attention : ne pas confondre charge de rupture et charge utile.
* Please note that the above figures are breaking load limits and not working load limits.



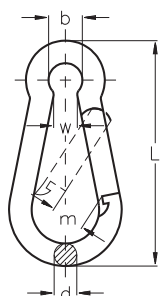

Mousqueton INOX
NIRO Snap hook

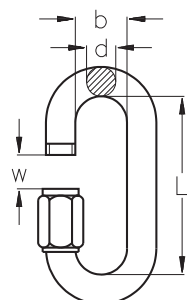
Désignation nominal size mm	b mm	d mm	L mm	m mm	w mm	N° article stock no.
50 x 5	8	5	50	7	4	309 200 050
60 x 6	9	6	60	9	5	309 200 060
70 x 7	11	7	70	8	8	309 200 070
80 x 8	12	8	80	9	8	309 200 080
100 x 10	15	10	100	12	10	309 200 100
120 x 11	18	11	120	16	11	309 200 120
140 x 12	21	12	142	23	17	309 200 140

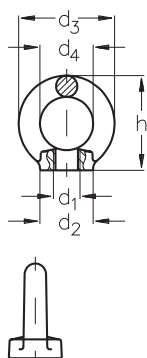

Maillon rapide INOX
NIRO Quick link

Désignation nominal size	b mm	d mm	L mm	w mm	N° article stock no.
4	10	4	33	5,5	309 300 004
5	12	5	39	6,5	309 300 005
6	13	6	45	7,5	309 300 006
7	16	7	53	8,5	309 300 007
8	16	8	59	10,0	309 300 008
10	20	10	70	12,0	309 300 010

Anneau taraudé INOX
filetage à droite

NIRO Eye nut
right hand thread

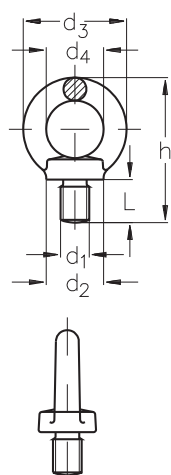
Désignation nominal size	d ₁	d ₂ mm	d ₃ mm	d ₄ mm	h mm	N° article stock no.
M 6	M 6	15	26,5	15	27	308 111 006
M 8	M 8	20	36	20	36	308 111 008
M 10	M 10	25	45	25	45	308 111 010
M 12	M 12	30	54	30	53	308 111 012
M 16	M 16	35	63	35	62	308 111 016
M 20	M 20	40	72	40	71	308 111 020
M 24	M 24	50	89	50	90	308 111 024
M 30	M 30	60	107	60	109	308 111 030

Anneau fileté INOX
filetage à droite

NIRO Eye bolt
right hand thread

Désignation nominal size	d ₁	d ₂ mm	d ₃ mm	d ₄ mm	L mm	h mm	N° article stock no.
M 6	M 6	15	26,5	15	10	37	308 110 006
M 8	M 8	20	36	20	13	49	308 110 008
M 10	M 10	25	45	25	17	62	308 110 010
M 12	M 12	30	54	30	20,5	73	308 110 012
M 16	M 16	35	63	35	26	90	308 110 016
M 20	M 20	40	72	40	30	101	308 110 020
M 24	M 24	50	89	50	35	125	308 110 024
M 30	M 30	60	107	60	45	132	308 110 030

Les éléments des pages 66 et 67 ne sont pas destinés au levage

Manille INOX droite
NIRO Shackle, U-type

Désignation nominal size	Rupture * breaking load * kg	d ₁ mm	d ₂ mm	d ₃ mm	b ₁ mm	h ₁ mm	N° article stock no.
5	1200	5	5	10	10	17	308 400 005
6	1500	6	6	12	12	21	308 400 006
8	2500	8	8	16	16	28	308 400 008
10	4500	10	10	19	19	35	308 400 010
12	6000	11	12	24	23	41	308 400 012
13	7000	13	13	26	26	45	308 400 013
16	8000	15	16	32	31	55	308 400 016
19	12000	18	19	38	38	66	308 400 019
22	15000	21	22	44	45	76	308 400 022
25	18000	24	25	50	50	87	308 400 025

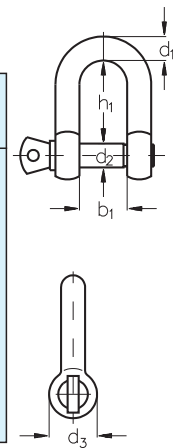

* Attention : ne pas confondre charge de rupture et charge utile.
* Please note that the above figures are breaking load limits and not working load limits.

Manille INOX lyre
NIRO Shackle, anchor type

Désignation nominal size	Rupture * breaking load * kg	d ₁ mm	d ₂ mm	d ₃ mm	b ₁ mm	b ₂ mm	h ₁ mm	N° article stock no.
4	500	4	4	8	8	14	18	308 300 004
5	1000	5	5	10	10	18	23	308 300 005
6	1600	6	6	12	12	21	27	308 300 006
8	2800	8	8	16	15	28	37	308 300 008
10	4000	10	10	20	19	35	46	308 300 010
12	5000	12	12	24	24	42	55	308 300 012

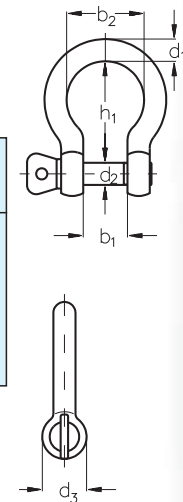

* Attention : ne pas confondre charge de rupture et charge utile.
* Please note that the above figures are breaking load limits and not working load limits.

Chaîne INOX, maille courte
NIRO Short link chain

Désignation nominal size	d mm	t mm	b mm	N° article stock no.
3	3	16,0	11	309 911 003
4	4	16,0	14	309 911 004
5	5	18,5	17	309 911 005
6	6	18,5	20	309 911 006
8	8	24,0	26	309 911 008
10	10	28,0	34	309 911 010

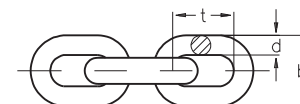
Chaîne INOX, maille longue
NIRO Long link chain

Désignation nominal size	d mm	t mm	b mm	N° article stock no.
3	3	26	13	309 910 003
4	4	32	16	309 910 004
5	5	36	20	309 910 005
6	6	42	24	309 910 006
8	8	54	32	309 910 008
10	10	66	40	309 910 010

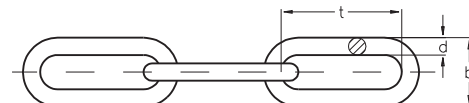

ASS[®]

Système
de Suspension
Hanging System



Werkfoto: Schroers & Schroers, 10827 Berlin





ASS Système de suspension

Malgré sa finesse, notre gamme **ASS** Mini et Super-Mini, utilisée à partir d'un câble de 3 mm est parfois, dans certains domaines d'application, surdimensionnée. Ceci est souvent le cas lorsque les charges à suspendre sont peu importantes.

Dans ce cas, nous vous conseillons d'utiliser nos Suspensions **ASS**.

Les tableaux par exemple, fixés par des câbles de seulement 1,5 mm paraissent flotter dans les airs et le regard ne sera pas dévié de l'essentiel.

Le montage de nos Suspensions **ASS** est tout à fait simple. Sans outil : régler, bloquer, monter ou échanger vite au moindre coût, ne sont que quelques-uns des avantages des Suspensions **ASS**.

Malgré un nombre limité de pièces, l'utilisation de notre gamme de Suspensions **ASS** offre d'innombrables possibilités.

Une élégance indémodable - pour des présentations professionnelles.

ASS Hanging System

*Our **ASS** Stainless Steel System for architectural use is designed for wire ropes from 3 mm diameter and this is often too large for certain applications. We have therefore introduced our **ASS** Hanging System which enables wire rope of only 1.5 mm to be used for hanging pictures. The system is unobtrusive and the pictures appear to be floating.*

*The **ASS** Hanging System is easy to assemble without need for any tools, is infinitely variable, self locking, quickly adjusted and cost effective to replace. The many advantages of the system are readily apparent and whilst the number of components are few the variety of uses are unlimited.*

Timeless elegance - For a professional presentation.











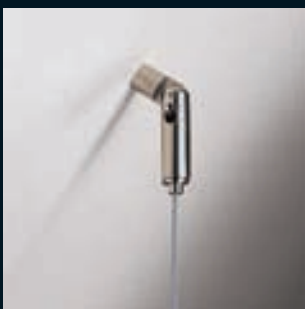
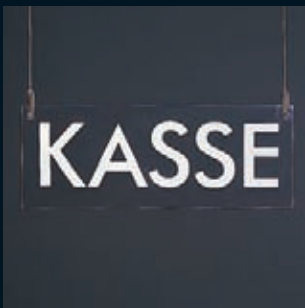
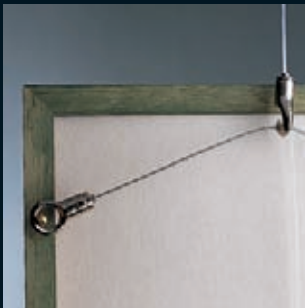
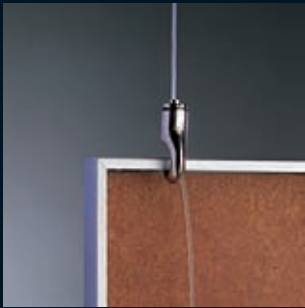

Schéma drawing	Désignation article	N° article stock no.		Schéma drawing	Désignation article	N° article stock no.	
	Boucle manchonnée pour suspension en Acier / Aluminium Rupt. 125 daN Pressed eye	387 010 001			Câble spécial Haute Résistance Ø 1,5 mm Special wire rope Ø 1,5 mm high ten- sile	387 010 014	
	Crochet fil roulé à sertir Acier zingué Rupt. environ 50 daN Pressed bent hook	387 010 006			Suspension à cro- chet réglable Acier coulé nickelé Rupt. 75 daN Sliding hook	387 010 003	
	Œil fil roulé à sertir Acier zingué Rupt. environ 50 daN Pressed bent eye	387 010 007			Suspension à œil réglable Acier coulé nickelé Rupt. 125 daN Sliding eye	387 010 002	
	Œil fermé à sertir Laiton nickelé Rupt. 125 daN Pressed eye terminal	387 010 016			Suspension réglable à flasque Laiton nickelé Rupt. 125 daN Sliding cylinder with flange	387 010 004	
	Goutte de suif à sertir Aluminium Rupt. 125 daN Pressed domed end stop	387 010 017			Suspension à boule réglable Laiton nickelé Rupt. 125 daN Sliding ball	387 010 008	
	Embout fileté à sertir M 4 x 10 Acier zingué Rupt. environ 125 daN Pressed threaded terminal	387 010 018			Suspension réglable striée pour tablette Laiton nickelé Rupt. 125 daN Sliding shelves support, knurled	387 010 019	

Veillez prendre en note que les articles présentés aux pages 70 et 71 ne sont pas en Inox.

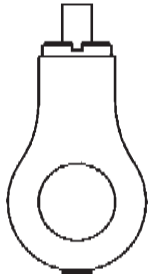
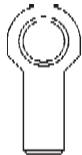
**Please note the material.
The items on page 70 and 71 are not made of stainless steel material.**



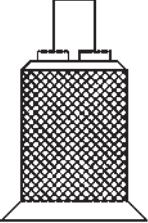



Schéma drawing	Désignation article	N° article stock no.	
	<p>Suspension articulée réglable avec filetage intérieur ou extérieur Laiton nickelé Rupt. 125 daN</p> <p>Sliding cylinder with internal or outside threaded link</p> <p>filetage intérieur <i>internal</i> M 5 M 6</p> <p>filetage extérieur <i>outside</i> M 5 M 6</p>	<p>387 011 005</p> <p>387 011 006</p> <p>387 012 005</p> <p>387 012 006</p>	
	<p>Attache plafond Laiton nickelé Rupt. 125 daN</p> <p>Ceiling support</p>	387 010 009	
	<p>Douille-Arrêt à sertir pour attache plafond (sans câble) Acier zingué Rupt. 125 daN</p> <p>Pressed nipple for ceiling support (without wire rope)</p>	387 010 020	
	<p>Suspension filetée réglable M 5, M 6, M 8 Laiton nickelé Rupt 125 daN</p> <p>Sliding cylinder with outside thread M 5, M 6, M 8</p>	<p>387 013 005</p> <p>387 013 006</p> <p>387 013 008</p>	

Schéma drawing	Désignation article	N° article stock no.	
	<p>Rail de suspension 3 m Aluminium verni</p> <p>Extruded picture support</p> <p>A l'achat de rail de suspension, nous vous livrons 5 crochets ainsi que le matériel d'assemblage.</p> <p><i>The extruded picture support will be delivered including 5 hooks and assembling material.</i></p>	387 010 011	
	<p>Crochet pour rail de suspension Acier coulé zingué</p> <p>Picture hook</p>	387 010 012	
	<p>Support simple pour tablette Laiton nickelé Rupt. 125 daN</p> <p>Sliding single shelf support</p>	387 010 021	
	<p>Support double pour tablette Laiton nickelé Rupt. 125 daN</p> <p>Sliding double shelf support</p>	387 010 022	
	<p>Attache sol réglable Laiton nickelé Rupt. 125 daN</p> <p>Floor support</p>	387 010 010	



Tous les éléments ci-dessus sont à l'échelle 1:1

All drawings scale 1:1

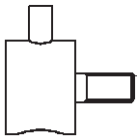
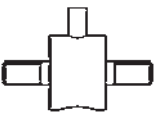
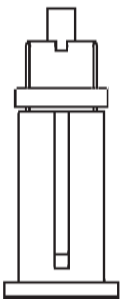
Ne pas confondre charge de rupture (rupt.) et charge utile.
Le calcul de la charge utile est le suivant : charge de rupture divisée par le coefficient de sécurité en vigueur.

Please note that the above figures are breaking load limits (BL) and not working load limits. To calculate the working load limit please divide the breaking load limit by the valid safety factor.

D'autres éléments sont disponibles sur demande.

Further types on request.

